

# Product Catalogue 2020 | 2021



**Camelion®**  
*...for more energy*

BATTERY • RECHARGEABLE • CHARGER • POWERBANK • FLASHLIGHT

[www.camelion.com](http://www.camelion.com)



BATTERY • RECHARGEABLE • CHARGER • POWERBANK • FLASHLIGHT

# CONTENT

## Primary Batteries

Lithium	6
9V Lithium	6
Digi Alkaline	7
Plus Alkaline	8
Super Heavy Duty (Blue)	14
Super Heavy Duty (Green)	15
Photo Lithium	18

## Electronic Button Cells

Electronics Lithium	19
Electronics Alkaline	20
Remote Control Batteries	21
Electronics Silver Oxide	22
Zinc Air	22
<b>Battery Accessoires</b>	<b>23</b>
<b>Battery Selection Chart</b>	<b>24</b>

## Rechargeable Batteries

AlwaysReady	26
Ni-MH	28
Lithium-ion	31

## Battery Chargers

### Ultra Fast Chargers

BC-0907	33
---------	----

### Super Fast Chargers

BC-0905A	34
BC-1010B	35

### Fast Chargers

BC-1002F	36
BC-1012	37

### Overnight Chargers

BC-1001A	38
BC-1009	39
BC-0901	40
BC-0904S	41

### Universal Chargers

CM9398GS	42
CM3298	43
CM9388	44
LBC-313-1	45

### Lithium-ion Charger

LBC-321	46
LBC-305	47

### Battery Charging Table

48

## Power Supplies

### Powerbanks

PS675, PS679 **51**

### USB Power Adapters

AD568, AD569 **52**

### USB Car Chargers

DD802, DD823A **53**

### 3in1 USB Charging Kit

AD568+DD811+CDC015 **54**

### Device Chart

**55**

## Battery Powered Flashlights

### 3W COB LED

S31 **57**

### SuperBright™ Flashlights

#### Classic Flashlight

FL1L2D, FL1L2C, FL1L2AA **58**

#### Multi-head LED Search Lamp

FL-16LED, FL-9LED **60**

#### LED Search Lamp

S32, CM25L **60**

#### Super Bright LED

SL3013 **62**

### TRAVLite™ Flashlights

#### LED Pocket Flashlight

HP7011 **64**

#### LED Rubber Flashlight

PT1L2D, PT1L2AA **64**

### Professional Products

#### Penlight

DL2AAAS **66**

#### Inspection Light

T11 **67**

### CT-Series LED Flashlights

High grade aluminium flashlight  
with maximum illumination

CT4004 **68**

#### Head Light

S58, CT4007 **70**

### Work Lights

SL5240N **72**

#### Multi Light 2 in 1

SL7280N **72**

#### Professional Work Light

S20, S21, S22 **74**

### Domestic Lighting

#### Sensor Light

SL7018 **76**

### Flashlight Replacement Bulbs

LED bulbs **77**

## Promotional

**78**



# **Primary Batteries**

---

## Batteries ▶ Lithium P7 ▶ 9V Lithium

# Lithium P<sup>7</sup> Batteries

Camelion Lithium P7™ batteries offer a unique combination of lightness and high energy density. As Camelion's most powerful primary battery, the P7 batteries, offer unbeatable performance for your high drain devices such as digital cameras, music players and games. It can be stored up to 10 years.



EMPORIO URTEIL	
Camelion Lithium AA	
<b>GUT</b>	81,7 %
22 AA-Batterien im Vergleichstest	Heft 11/2008



### FR6-BP2

1.5V AA



#### Packaging

Blister	2 pcs/pack	Gross Weight:	9.3 kg
Inner Box	12 packs/box	Volume:	0.0251 cbm
Outer Carton	216 packs/carton		

#### Dimensions

Blister (mm)	84(W) x 114(H) x 15(D)
Inner Box (mm)	131(L) x 98(W) x 86(H)
Outer Carton (cm)	41.5(L) x 27.5(W) x 22.0(H)



### FR03-BP2

1.5V AAA



#### Packaging

Blister	2 pcs/pack	Gross Weight:	8.0 kg
Inner Box	12 packs/box	Volume:	0.0237 cbm
Outer Carton	288 packs/carton		

#### Dimensions

Blister (mm)	84(W) x 114(H) x 11(D)
Inner Box (mm)	119(L) x 75(W) x 86(H)
Outer Carton (cm)	32.5(L) x 26.0(W) x 28.0(H)

## 9V Lithium Battery

The new Lithium 9V Battery from Camelion is a high capacity battery designed to provide long lasting life and stable operating voltage.

- Up to 5x Longer Lasting\*
- Low Self Discharge
- Anti leakage crimp design
- Temperature Range -20°C to +55°C
- Non-rechargeable
- 10 Year Shelf Life
- High And Stable Operating Voltage

\*compare with alkaline batteries. Camelion 2010 Lab Tests.



### CR9V-SP1

9V



#### Packaging

Shrink	1 pcs/pack	Gross Weight:	14.5 kg
Inner Box	20 packs/box	Volume:	0.0083 cbm
Outer Carton	200 packs/carton		

#### Dimensions

Shrink (mm)	25.5(W) x 48.5(H) x 17.5 (D)
Inner Box (mm)	145(L) x 74(W) x 54(H)
Outer Carton (cm)	39.0(L) x 17.5(W) x 13.5(H)



### CR9V-BP1

9V



#### Packaging

Blister	1 pcs/pack	Gross Weight:	8.3 kg
Inner Box	12 packs/box	Volume:	0.0246 cbm
Outer Carton	192 packs/carton		

#### Dimensions

Blister (mm)	84(W) x 114(H) x 18(D)
Inner Box (mm)	123(L) x 117(W) x 86(H)
Outer Carton (cm)	36.2(L) x 26.3(W) x 25.8(H)

## ► Digi Alkaline

# Digi Alkaline Batteries

Camelion Digi Alkaline batteries are the right solution for many electronic devices including digital cameras, music players, and boom boxes. Using a new technology they offer long lasting power for high drain devices.



**LR20-BP2DG**  
1.5V D  
4 260216 453885

**Packaging**  
Blister 2 pcs/pack  
Inner Box 6 packs/box  
Outer Carton 48 packs/carton

**Gross Weight:** 15.0 kg  
**Volume:** 0.0157 cbm

**Dimensions**  
Blister (mm) 84(W) x 114(H) x 34(D)  
Inner Box (mm) 160(L) x 110(W) x 92(H)  
Outer Carton (cm) 33.5(L) x 19.5(W) x 24.0(H)



**LR14-BP2DG**  
1.5V C  
4 260216 453892

**Packaging**  
Blister 2 pcs/pack  
Inner Box 6 packs/box  
Outer Carton 96 packs/carton

**Gross Weight:** 14.3 kg  
**Volume:** 0.0227 cbm

**Dimensions**  
Blister (mm) 84(W) x 114(H) x 27(D)  
Inner Box (mm) 140(L) x 90(W) x 92(H)  
Outer Carton (cm) 37.5(L) x 29.5(W) x 20.5(H)



**LR6-BP4DG**  
1.5V AA  
4 260033 154521

**Packaging**  
Blister 4 pcs/pack  
Inner Box 12 packs/box  
Outer Carton 144 packs/carton

**Gross Weight:** 15.4 kg  
**Volume:** 0.0166 cbm

**Dimensions**  
Blister (mm) 84(W) x 114(H) x 15(D)  
Inner Box (mm) 131(L) x 98(W) x 86(H)  
Outer Carton (cm) 27.5(L) x 28.0(W) x 21.5(H)



**LR6-BP2DG**  
1.5V AA  
4 260033 154538

**Packaging**  
Blister 2 pcs/pack  
Inner Box 12 packs/box  
Outer Carton 216 packs/carton

**Gross Weight:** 12.6 kg  
**Volume:** 0.0251 cbm

**Dimensions**  
Blister (mm) 84(W) x 114(H) x 15(D)  
Inner Box (mm) 131(L) x 98(W) x 86(H)  
Outer Carton (cm) 41.5(L) x 27.5(W) x 22.0(H)



**LR03-BP4DG**  
1.5V AAA  
4 260033 154545

**Packaging**  
Blister 4 pcs/pack  
Inner Box 12 packs/box  
Outer Carton 288 packs/carton

**Gross Weight:** 15.9 kg  
**Volume:** 0.0237 cbm

**Dimensions**  
Blister (mm) 84(W) x 114(H) x 11(D)  
Inner Box (mm) 119(L) x 75(W) x 86(H)  
Outer Carton (cm) 32.5(L) x 26.0(W) x 28.0(H)



**LR03-BP2DG**  
1.5V AAA  
4 260033 154552

**Packaging**  
Blister 2 pcs/pack  
Inner Box 12 packs/box  
Outer Carton 288 packs/carton

**Gross Weight:** 9.1 kg  
**Volume:** 0.0237 cbm

**Dimensions**  
Blister (mm) 84(W) x 114(H) x 11(D)  
Inner Box (mm) 119(L) x 75(W) x 86(H)  
Outer Carton (cm) 32.5(L) x 26.0(W) x 28.0(H)



**6LR61-BP1DG**  
9V  
4 260216 454028

**Packaging**  
Blister 1 pcs/pack  
Inner Box 12 packs/box  
Outer Carton 192 packs/carton

**Gross Weight:** 11.2 kg  
**Volume:** 0.0246 cbm

**Dimensions**  
Blister (mm) 84(W) x 114(H) x 18(D)  
Inner Box (mm) 123(L) x 117(W) x 86(H)  
Outer Carton (cm) 36.2(L) x 26.3(W) x 25.8(H)

# Batteries ▶ Plus Alkaline



## Plus Alkaline Batteries

Camelion Plus Alkaline batteries offer reliable power for high drain devices. They deliver stable and long lasting current couple to a long shelf life to support high drain devices such as CD players, toys, PDAs, and electronic games.



### LR20-BP2

1.5V D



#### Packaging

Blister	2 pcs/pack	Gross Weight:	15.0 kg
Inner Box	6 packs/box	Volume:	0.0157 cbm
Outer Carton	48 packs/carton		

#### Dimensions

Blister (mm)	84(W) x 114(H) x 34(D)
Inner Box (mm)	160(L) x 110(W) x 92(H)
Outer Carton (cm)	33.5(L) x 19.5(W) x 24.0(H)



### LR14-BP2

1.5V C



#### Packaging

Blister	2 pcs/pack	Gross Weight:	15.6 kg
Inner Box	6 packs/box	Volume:	0.0227 cbm
Outer Carton	96 packs/carton		

#### Dimensions

Blister (mm)	84(W) x 114(H) x 27(D)
Inner Box (mm)	140(L) x 90(W) x 92(H)
Outer Carton (cm)	37.5(L) x 29.5(W) x 20.5(H)



### LR6-BP4

1.5V AA



#### Packaging

Blister	4 pcs/pack	Gross Weight:	15.5 kg
Inner Box	12 packs/box	Volume:	0.0166 cbm
Outer Carton	144 packs/carton		

#### Dimensions

Blister (mm)	84(W) x 114(H) x 15(D)
Inner Box (mm)	131(L) x 98(W) x 86(H)
Outer Carton (cm)	27.5(L) x 28.0(W) x 21.5(H)



### LR6-BP2

1.5V AA



#### Packaging

Blister	2 pcs/pack	Gross Weight:	12.6 kg
Inner Box	12 packs/box	Volume:	0.0251 cbm
Outer Carton	216 packs/carton		

#### Dimensions

Blister (mm)	84(W) x 114(H) x 15(D)
Inner Box (mm)	131(L) x 98(W) x 86(H)
Outer Carton (cm)	41.5(L) x 27.5(W) x 22.0(H)



### LR03-BP4

1.5V AAA



#### Packaging

Blister	4 pcs/pack	Gross Weight:	8.3 kg
Inner Box	12 packs/box	Volume:	0.0120 cbm
Outer Carton	144 packs/carton		

#### Dimensions

Blister (mm)	84(W) x 114(H) x 11(D)
Inner Box (mm)	119(L) x 75(W) x 86(H)
Outer Carton (cm)	27.5(L) x 25.5(W) x 17.0(H)



### LR03-BP2

1.5V AAA



#### Packaging

Blister	2 pcs/pack	Gross Weight:	9.1 kg
Inner Box	12 packs/box	Volume:	0.0237 cbm
Outer Carton	288 packs/carton		

#### Dimensions

Blister (mm)	84(W) x 114(H) x 11(D)
Inner Box (mm)	119(L) x 75(W) x 86(H)
Outer Carton (cm)	32.5(L) x 26.0(W) x 28.0(H)



### 4+4LR6

1.5V AA



#### Packaging

Blister	8 pcs/pack	Gross Weight:	15.5 kg
Inner Box	12 packs/box	Volume:	0.0199 cbm
Outer Carton	72 packs/carton		

#### Dimensions

Blister (mm)	168(W) x 114(H) x 15(D)
Inner Box (mm)	175(L) x 140(W) x 10.8(H)
Outer Carton (cm)	43.5(L) x 19.0(W) x 24.0(H)



### 4+4LR03

1.5V AAA



#### Packaging

Blister	8 pcs/pack	Gross Weight:	8.9 kg
Inner Box	12 packs/box	Volume:	0.0150 cbm
Outer Carton	72 packs/carton		

#### Dimensions

Blister (mm)	168(W) x 114(H) x 11(D)
Inner Box (mm)	175(L) x 130(W) x 85(H)
Outer Carton (cm)	41.5(L) x 19.0(W) x 19.0(H)





## LR6-BP10

**1.5V AA**



Packaging		Gross Weight:
Blister	10 pcs/pack	18.8 kg
Inner Box	12 packs/box	Volume:
Outer Carton	72 packs/carton	0.0239 cbm

### Dimensions

Blister (mm)	84(W) x 190(H) x 15(D)
Inner Box (mm)	315(L) x 104(W) x 90(H)
Outer Carton (cm)	33.0(L) x 31.5(W) x 23.0(H)



## LR03-BP10

**1.5V AAA**



Packaging		Gross Weight:
Blister	10 pcs/pack	9.4 kg
Inner Box	12 packs/box	Volume:
Outer Carton	72 packs/carton	0.0152 cbm

### Dimensions

Blister (mm)	84(W) x 165(H) x 11(D)
Inner Box (mm)	243(L) x 85(W) x 90(H)
Outer Carton (cm)	30.0(L) x 26.0(W) x 19.5(H)



## LR6-HP12

**1.5V AA**



Packaging		Gross Weight:
Blister	12 pcs/pack	14.1 kg
Outer Carton	48 packs/carton	Volume:
		0.0098 cbm

### Dimensions

Blister (mm)	170(W) x 99(H) x 15(D)
Outer Carton (cm)	35.5(L) x 22.0(W) x 12.5(H)



## 6LR61-BP1

**9V**



Packaging		Gross Weight:
Blister	1 pcs/pack	11.2 kg
Inner Box	12 packs/box	Volume:
Outer Carton	192 packs/carton	0.0246 cbm

### Dimensions

Blister (mm)	84(W) x 114(H) x 18(D)
Inner Box (mm)	123(L) x 117(W) x 86(H)
Outer Carton (cm)	36.2(L) x 26.3(W) x 25.8(H)



## LR1-BP2

**1.5V N**



Packaging		Gross Weight:
Blister	2 pcs/pack	6.3 kg
Inner Box	6 packs/box	Volume:
Outer Carton	192 packs/carton	0.0181 cbm

### Dimensions

Blister (mm)	84(W) x 114(H) x 12(D)
Inner Box (mm)	116(L) x 45(W) x 86(H)
Outer Carton (cm)	36.2(L) x 25.0(W) x 20.0(H)



## LR1-BP5

**1.5V N**



Packaging		Gross Weight:
Blister	5 pcs/pack	10.8 kg
Inner Box	12 packs/box	Volume:
Outer Carton	192 packs/carton	0.0150 cbm

### Dimensions

Blister (mm)	50(W) x 160(H) x (D)
Inner Box (mm)	170(L) x 78(W) x 52(H)
Outer Carton (cm)	33.5(L) x 19.0(W) x 23.5(H)



## LR61-BP2

**1.5V AAAA**



Packaging		Gross Weight:
Blister	2 pcs/pack	6.2 kg
Inner Box	12 packs/box	Volume:
Outer Carton	288 packs/carton	0.0251 cbm

### Dimensions

Blister (mm)	84(W) x 114(H) x 11(D)
Inner Box (mm)	128(L) x 75(W) x 86(H)
Outer Carton (cm)	32.5(L) x 27.6(W) x 28.0(H)



## 3LR12-BP1

**4.5V**



Packaging		Gross Weight:
Blister	1 pcs/pack	16.9 kg
Inner Box	6 packs/box	Volume:
Outer Carton	144 packs/carton	0.0295 cbm

### Dimensions

Blister (mm)	84(W) x 114(H) x 23(D)
Inner Box (mm)	160(L) x 75(W) x 86(H)
Outer Carton (cm)	36.0(L) x 33.5(W) x 24.5(H)



## LR6 bulk

**1.5V AA**

Packaging		Gross Weight:
Inner Box	60 pcs/box	17.8 kg
Outer Carton	720 pcs/carton	Volume:
Dimensions		0.0096 cbm

Single (mm)	14(W) x 50(H) x 14(D)
Inner Box (mm)	174(L) x 72(W) x 50(H)
Outer Carton (cm)	23.5(L) x 21.5(W) x 19.0(H)



## LR03 bulk

**1.5V AAA**

Packaging		Gross Weight:
Inner Box	60 pcs/box	14.7 kg
Outer Carton	1200 pcs/carton	Volume:
		0.0084 cbm

### Dimensions

Single (mm)	10(W) x 44.5(H) x 10(D)
Inner Box (mm)	83(L) x 52(W) x 45(H)
Outer Carton (cm)	29.0(L) x 19.0(W) x 15.0(H)



# Batteries ▶ Plus Alkaline



**LR6-SP40HFB** 

**1.5V AA** 4 260216 456428

<b>Packaging</b>		<b>Gross Weight:</b> 11.7 kg
Shrink	40 pcs/pack	
Outer Carton	12 packs/carton	
<b>Dimensions</b>		<b>Volume:</b> 0.0075 cbm
Shrink (mm)	145(L) x 60(W) x 50(H)	
Outer Carton (cm)	30.5(L) x 17.5(W) x 14.0(H)	



**LR03-SP40HFB** 

**1.5V AAA** 4 260216 456435

<b>Packaging</b>		<b>Gross Weight:</b> 10.8 kg
Shrink	40 pcs/pack	
Outer Carton	16 packs/carton	
<b>Dimensions</b>		<b>Volume:</b> 0.0051 cbm
Shrink (mm)	106(L) x 44(W) x 46(H)	
Outer Carton (cm)	23.0(L) x 20.0(W) x 11.0(H)	



**LR6-SP4** 

**1.5V AA** 4 260033 150325

<b>Packaging</b>		<b>Gross Weight:</b> 17.8 kg
Shrink	4 pcs/pack	
Outer Carton	180 packs/carton	
<b>Dimensions</b>		<b>Volume:</b> 0.0096 cbm
Shrink (mm)	56(W) x 50(H) x 14(D)	
Outer Carton (cm)	23.5(L) x 21.5(W) x 19.0(H)	



**LR6-SP2** 

**1.5V AA** 4 260033 150332

<b>Packaging</b>		<b>Gross Weight:</b> 17.9 kg
Shrink	2 pcs/pack	
Outer Carton	360 packs/carton	
<b>Dimensions</b>		<b>Volume:</b> 0.0100 cbm
Shrink (mm)	28(W) x 50(H) x 14(D)	
Outer Carton (cm)	31.5(L) x 23.5(W) x 13.5(H)	



**LR03-SP4** 

**1.5V AAA** 4 260033 150349

<b>Packaging</b>		<b>Gross Weight:</b> 14.7 kg
Shrink	4 pcs/pack	
Outer Carton	300 packs/carton	
<b>Dimensions</b>		<b>Volume:</b> 0.0084 cbm
Shrink (mm)	40(W) x 44.5(H) x 10(D)	
Outer Carton (cm)	29.0(L) x 20.0(W) x 14.5(H)	



**LR03-SP2** 

**1.5V AAA** 4 260033 150356

<b>Packaging</b>		<b>Gross Weight:</b> 14.8 kg
Shrink	2 pcs/pack	
Outer Carton	600 packs/carton	
<b>Dimensions</b>		<b>Volume:</b> 0.0083 cbm
Shrink (mm)	20(W) x 44.5(H) x 10(D)	
Outer Carton (cm)	29.0(L) x 19.0(W) x 15.0(H)	



**LR14-SP2** 

**1.5V C** 4 260033 150318

<b>Packaging</b>		<b>Gross Weight:</b> 16.6 kg
Shrink	2 pcs/pack	
Outer Carton	120 packs/carton	
<b>Dimensions</b>		<b>Volume:</b> 0.0123 cbm
Shrink (mm)	52(W) x 50(H) x 26(D)	
Outer Carton (cm)	29.5(L) x 22.5(W) x 18.5(H)	



**LR20-SP2** 

**1.5V D** 4 260033 150301

<b>Packaging</b>		<b>Gross Weight:</b> 16.7 kg
Shrink	2 pcs/pack	
Outer Carton	60 packs/carton	
<b>Dimensions</b>		<b>Volume:</b> 0.0122 cbm
Shrink (mm)	66(W) x 61(H) x 33(D)	
Outer Carton (cm)	35.5(L) x 15.0(W) x 23.0(H)	



**6LR61-SP1** 

**9V** 4 260033 150363

<b>Packaging</b>		<b>Gross Weight:</b> 11.4 kg
Shrink	1 pcs/pack	
Outer Carton	240 packs/carton	
<b>Dimensions</b>		<b>Volume:</b> 0.0083 cbm
Shrink (mm)	25.5(W) x 48.5(H) x 17.5 (D)	
Outer Carton (cm)	29.0(L) x 23.0(W) x 12.5(H)	



**3LR12-SP1** 

**4.5V** 4 260033 150370

<b>Packaging</b>		<b>Gross Weight:</b> 16.6 kg
Shrink	1 pcs/pack	
Outer Carton	192 packs/carton	
<b>Dimensions</b>		<b>Volume:</b> 0.0233 cbm
Shrink (mm)	62(W) x 65.5 (H) x 22 (D)	
Outer Carton (cm)	38.5(L) x 20.5(W) x 29.5(H)	



**LR6-PB24**  
**1.5V AA** 4 260033 150455

**Packaging**  
**Box** 24 pcs/pack **Gross Weight:** 18.3 kg  
**Outer Carton** 30 packs/carton **Volume:** 0.0178 cbm

**Dimensions**  
**Plastic box (mm)** 98(L) x 75(W) x 50(H)  
**Outer Carton (cm)** 42.5(L) x 22(W) x 19(H)



**LR03-PB24**  
**1.5V AAA** 4 260033 150462

**Packaging**  
**Box** 24 pcs/pack **Gross Weight:** 9.0 kg  
**Outer Carton** 30 packs/carton **Volume:** 0.0107 cbm

**Dimensions**  
**Plastic box (mm)** 80(L) x 60(W) x 45(H)  
**Outer Carton (cm)** 34.5(L) x 18.5(W) x 17.0(H)



**LR6-PB20**  
**1.5V AA** 4 260216 453106

**Packaging**  
**Box** 20 pcs/pack **Gross Weight:** 15.0 kg  
**Outer Carton** 30 packs/carton **Volume:** 0.0150 cbm

**Dimensions**  
**Plastic box (mm)** 82(L) x 75(W) x 50(H)  
**Outer Carton (cm)** 43.0(L) x 19.2(W) x 19.0(H)



**LR03-PB20**  
**1.5V AAA** 4 260216 453113

**Packaging**  
**Box** 20 pcs/pack **Gross Weight:** 7.8 kg  
**Outer Carton** 30 packs/carton **Volume:** 0.0074 cbm

**Dimensions**  
**Plastic box (mm)** 66(L) x 64(W) x 44(H)  
**Outer Carton (cm)** 34.5(L) x 15.5(W) x 17.5(H)



**6LR61-PB6**  
**9V** 4 260033 150479

**Packaging**  
**Box** 6 pcs/pack **Gross Weight:** 7.8 kg  
**Inner Box** 6 packs/box **Volume:** 0.0105 cbm  
**Outer Carton** 24 packs/carton

**Dimensions**  
**Plastic box (mm)** 71(L) x 68(W) x 49 (H)  
**Inner Box (mm)** 210(L) x 148(W) x 60(H)  
**Outer Carton (cm)** 31.0(L) x 22.5(W) x 15.0(H)



**LR03-PBH24**  
**1.5V AAA** 4 260033 155108

**Packaging**  
**Box** 24 pcs/pack **Gross Weight:** 8.8 kg  
**Inner Box** 12 packs/box **Volume:** 0.0067 cbm  
**Outer Carton** 24 packs/carton

**Dimensions**  
**Plastic box (mm)** 96(L) x 70(W) x 26(H)  
**Inner Box (mm)** 21.5(L) x 200(W) x 55(H)  
**Outer Carton (cm)** 23.0(L) x 21.5(W) x 13.5(H)



**LR6-PBH24**  
**1.5V AA** 4 260033 155092

**Packaging**  
**Box** 24 pcs/pack **Gross Weight:** 16.3 kg  
**Inner Box** 12 packs/box **Volume:** 0.0116 cbm  
**Outer Carton** 24 packs/carton

**Dimensions**  
**Plastic box (mm)** 108(L) x 92(W) x 32(H)  
**Inner Box (mm)** 285(L) x 220(W) x 70(H)  
**Outer Carton (cm)** 30.0 (L) x 23.5(W) x 16.5(H)



**CM-FA-01**  
 4 260033 155160

**Packaging** 10 x LR6 + 8 x LR03+  
 2 x 6LF22 + 4xC Size Adaptors+  
 4 x D Size Adaptors+BT-0503 **Gross Weight:** 8.0 kg  
**Outer Carton** 10 boxes/carton **Volume:** 0.0195 cbm

**Dimensions**  
**Plastic box (mm)** 255(L) x 173(W) x 37(H)  
**Outer Carton (cm)** 35.5 (L) x 20.0(W) x 27.5(H)

## Shrink Wrap Packaging and Display Boxes

### Handy Packaging!

Our shrink wrap packaging and display boxes help keep your batteries where you need them, with minimum fuss.

- Convenient, portable and durable
- Self-standing, sturdy display boxes
- Many sizes and shapes available
- Securely hold several batteries
- Professionally branded card inserts and designs for effective messaging



**LR6-SP10-DA**



**1.5V AA**

4 260033 157249

**Packaging**

**Blister** 10 pcs/pack  
**Inner Box** 24 packs/box  
**Outer Carton** 2 boxes/carton

**Gross Weight:** 14.0 kg  
**Volume:** 0.0087 cbm

**Dimensions**

**Inner Box (mm)** 150(L) x 190(W) x 108(H)  
**Outer Carton (cm)** 32.0(L) x 20.5(W) x 12.5(H)



**LR03-SP10-DA**



**1.5V AAA**

4 260033 157256

**Packaging**

**Blister** 10 pcs/pack  
**Inner Box** 20 packs/box  
**Outer Carton** 4 boxes/carton

**Gross Weight:** 12.0 kg  
**Volume:** 0.0075 cbm

**Dimensions**

**Inner Box (mm)** 110(L) x 120(W) x 96(H)  
**Outer Carton (cm)** 26.0(L) x 24.0(W) x 11.0(H)



**LR6-SP10+2-DA**



**1.5V AA**

4 260216 455643

**Packaging**

**Blister** 12 pcs/pack  
**Inner Box** 20 packs/box  
**Outer Carton** 2 boxes/carton

**Gross Weight:** 11.8 kg  
**Volume:** 0.0079 cbm

**Dimensions**

**Inner Box (mm)** 175(L) x 150(W) x 110(H)  
**Outer Carton (cm)** 31.5(L) x 19.0(W) x 13.2(H)



**LR03-SP10+2-DA**



**1.5V AAA**

4 260216 455650

**Packaging**

**Blister** 12 pcs/pack  
**Inner Box** 20 packs/box  
**Outer Carton** 4 boxes/carton

**Gross Weight:** 11.8 kg  
**Volume:** 0.0075 cbm

**Dimensions**

**Inner Box (mm)** 130(L) x 110(W) x 100(H)  
**Outer Carton (cm)** 23.5(L) x 14.5(W) x 22.0(H)

## Limited edition

### Value pack for limited campaign

#### DR-29



#### DR29 promotion display 10+2

- Plus alkaline floor display for LR6-SP10+2 & LR03-SP10+2 (AA/AAA)
- Hight(total) 1.17 m + Pallet
- Width 0.485 m
- Depth 0.335 m
- Material Cardboard
- Surface shiny

#### DR-16 (24)



#### LR6-PB24

1.5V AA



##### Packaging

Box 24 pcs/pack  
Outer Carton 30 packs/carton

Gross Weight: 18.3 kg  
Volume: 0.0178 cbm

##### Dimensions

Plastic box (mm) 98(L) x 75(W) x 50(H)  
Outer Carton (cm) 42.5(L) x 22(W) x 19(H)

#### DR16 Promotion Display "24"

- Plus Alkaline floor display for plastic box "24" (AA | AAA)
- Hight (total) 1,17m + palett
- Width 0,55m
- Depth 0,38m
- Material Cardboard
- Surface shiny
- 32x grids = 32 storage compartments
- 60 x LR6 „24“ (20 storage compartments)  
3 boxes per storage compartment
- 48 x LR03 „24“ (12 storage compartments)  
4 boxes per storage compartment
- 108 boxes total



#### LR03-PB24

1.5V AAA



##### Packaging

Box 24 pcs/pack  
Outer Carton 30 packs/carton

Gross Weight: 9.0 kg  
Volume: 0.0107 cbm

##### Dimensions

Plastic box (mm) 80(L) x 60(W) x 45(H)  
Outer Carton (cm) 34.5(L) x 18.5(W) x 17.0(H)



# Batteries ▶ Super Heavy Duty

## Super Heavy Duty Batteries

Camelion Zinc Carbon batteries are a great choice for small household electronic devices that need continuous power such as clocks, flashlights, remote controls and transistor radios. Manganese dioxide is used for the positive material and zinc/ammonium chloride for the electrolyte in a leakage proof structure. These, general purpose, batteries offer a long shelf life as well as reliability, versatility and savings.



**R20P-BP2B**  
**1.5V D**  
 4 260033 151018

<b>Packaging</b>		
Blister	2 pcs/pack	<b>Gross Weight:</b> 14.9 kg
Inner Box	6 packs/box	<b>Volume:</b> 0.0238 cbm
Outer Carton	72 packs/carton	
<b>Dimensions</b>		
Blister (mm)	84(W) x 114(H) x 34(D)	
Inner Box (mm)	160(L) x 110(W) x 92(H)	
Outer Carton (cm)	33.5(L) x 29.0(W) x 24.5(H)	



**R14P-BP2B**  
**1.5V C**  
 4 260033 151025

<b>Packaging</b>		
Blister	2 pcs/pack	<b>Gross Weight:</b> 15.6 kg
Inner Box	6 packs/box	<b>Volume:</b> 0.0315 cbm
Outer Carton	144 packs/carton	
<b>Dimensions</b>		
Blister (mm)	84(W) x 114(H) x 27(D)	
Inner Box (mm)	137(L) x 86(W) x 86(H)	
Outer Carton (cm)	37.5(L) x 29.5(W) x 28.5(H)	



**R6P-BP4B**  
**1.5V AA**  
 4 260033 151049

<b>Packaging</b>		
Blister	4 pcs/pack	<b>Gross Weight:</b> 17.5 kg
Inner Box	12 packs/box	<b>Volume:</b> 0.0272cbm
Outer Carton	240 packs/carton	
<b>Dimensions</b>		
Blister (mm)	84(W) x 114(H) x 15(D)	
Inner Box (mm)	131(L) x 98(W) x 86(H)	
Outer Carton (cm)	45.0(L) x 27.5(W) x 22.0(H)	



**R03P-BP4B**  
**1.5V AAA**  
 4 260033 151070

<b>Packaging</b>		
Blister	4 pcs/pack	<b>Gross Weight:</b> 14.6 kg
Inner Box	12 packs/box	<b>Volume:</b> 0.0237cbm
Outer Carton	288 packs/carton	
<b>Dimensions</b>		
Blister (mm)	84(W) x 114(H) x 11(D)	
Inner Box (mm)	119(L) x 75(W) x 86(H)	
Outer Carton (cm)	32.5(L) x 26.0(W) x 28.0(H)	



**R6P-HP12B**  
**1.5V AA**  
 4 260033 151438

<b>Packaging</b>		
Blister	12 pcs/pack	<b>Gross Weight:</b> 9.3 kg
Inner Box	12 packs/box	<b>Volume:</b> 0.0098cbm
Outer Carton	48 packs/carton	
<b>Dimensions</b>		
Blister (mm)	170(W) x 100(H) x 15(D)	
Outer Carton (cm)	23.5(L) x 25.5(W) x 20.5(H)	



**6F22-BP1B**  
**9V**  
 4 260033 151094

<b>Packaging</b>		
Blister	1 pcs/pack	<b>Gross Weight:</b> 11.4 kg
Inner Box	12 packs/box	<b>Volume:</b> 0.0310 cbm
Outer Carton	240 packs/carton	
<b>Dimensions</b>		
Blister (mm)	84(W) x 114(H) x 18(D)	
Inner Box (mm)	123(L) x 117(W) x 86(H)	
Outer Carton (cm)	45.0(L) x 27.0(W) x 25.5(H)	



**R20P-BP2G**  
**1.5V D**  
 4 260033 156280

<b>Packaging</b>		
Blister	2 pcs/pack	<b>Gross Weight:</b> 14.3 kg
Inner Box	6 packs/box	<b>Volume:</b> 0.0238cbm
Outer Carton	72 packs/carton	
<b>Dimensions</b>		
Blister (mm)	84(W) x 114(H) x 34(D)	
Inner Box (mm)	160(L) x 110(W) x 92(H)	
Outer Carton (cm)	33.5(L) x 29.0(W) x 24.5(H)	



**R20P-BP4G**  
**1.5V D**  
 4 260033 156358

<b>Packaging</b>		
Blister	4 pcs/pack	<b>Gross Weight:</b> 20.6 kg
Inner Box	6 packs/box	<b>Volume:</b> 0.0340cbm
Outer Carton	54 packs/carton	
<b>Dimensions</b>		
Blister (mm)	84(W) x 190(H) x 34(D)	
Inner Box (mm)	290(L) x 110(W) x 90(H)	
Outer Carton (cm)	31.0(L) x 30.5(W) x 36.0(H)	





**R14P-BP2G**  
**1.5V C**  
 4 260033 156297

**Packaging**  
 Blister 2 pcs/pack  
 Inner Box 6 packs/box  
 Outer Carton 144 packs/carton

**Gross Weight:** 14.9 kg  
**Volume:** 0.0315 cbm

**Dimensions**  
 Blister (mm) 84(W) x 114(H) x 27(D)  
 Inner Box (mm) 137(L) x 86(W) x 86(H)  
 Outer Carton (cm) 37.5(L) x 29.5(W) x 28.5(H)



**R14P-BP4G**  
**1.5V C**  
 4 260033 156389

**Packaging**  
 Blister 4 pcs/pack  
 Inner Box 6 packs/box  
 Outer Carton 54 packs/carton

**Gross Weight:** 10.4 kg  
**Volume:** 0.0245cbm

**Dimensions**  
 Blister (mm) 84(W) x 165(H) x 27(D)  
 Inner Box (mm) 240(L) x 90(W) x 90(H)  
 Outer Carton (cm) 32.0(L) x 25.5(W) x 30.0(H)



**R14P-BP6G**  
**1.5V C**  
 4 260033 150936

**Packaging**  
 Blister 6 pcs/pack  
 Inner Box 4 packs/box  
 Outer Carton 48 packs/carton

**Gross Weight:** 15 kg  
**Volume:** 0.0336 cbm

**Dimensions**  
 Blister (mm) 84(W) x 210(H) x 27(D)  
 Inner Box (mm) 220(L) x 110(W) x 90(H)  
 Outer Carton (cm) 46.5(L) x 24.5(W) x 29.5(H)



**R6P-BP8G**  
**1.5V AA**  
 4 260033 156402

**Packaging**  
 Blister 8 pcs/pack  
 Inner Box 12 packs/box  
 Outer Carton 72 packs/carton

**Gross Weight:** 9.5 kg  
**Volume:** 0.0198 cbm

**Dimensions**  
 Blister (mm) 84(W) x 165(H) x 15(D)  
 Inner Box (mm) 265(L) x 100(W) x 90(H)  
 Outer Carton (cm) 31.5(L) x 28.0(W) x 22.5(H)



**R6P-BP4G**  
**1.5V AA**  
 4 260033 156303

**Packaging**  
 Blister 4 pcs/pack  
 Inner Box 12 packs/box  
 Outer Carton 240 packs/carton

**Gross Weight:** 16.3 kg  
**Volume:** 0.0272cbm

**Dimensions**  
 Blister (mm) 84(W) x 114(H) x 15(D)  
 Inner Box (mm) 131(L) x 98(W) x 86(H)  
 Outer Carton (cm) 45.0(L) x 27.5(W) x 22.0(H)



**R6P-BP10G**  
**1.5V AA**  
 4 260033 156396

**Packaging**  
 Blister 10 pcs/pack  
 Inner Box 12 packs/box  
 Outer Carton 72 packs/carton

**Gross Weight:** 12.1 kg  
**Volume:** 0.0239 cbm

**Dimensions**  
 Blister (mm) 84(W) x 190(H) x 15(D)  
 Inner Box (mm) 315(L) x 104(W) x 90(H)  
 Outer Carton (cm) 33.0(L) x 31.5(W) x 23.0(H)



**R03P-BP4G**  
**1.5V AAA**  
 4 260033 156327

**Packaging**  
 Blister 4 pcs/pack  
 Inner Box 12 packs/box  
 Outer Carton 288 packs/carton

**Gross Weight:** 12.0 kg  
**Volume:** 0.0237cbm

**Dimensions**  
 Blister (mm) 84(W) x 114(H) x 11(D)  
 Inner Box (mm) 119(L) x 75(W) x 86(H)  
 Outer Carton (cm) 32.5(L) x 26.0(W) x 28.0(H)



**R03P-BP8G**  
**1.5V AAA**  
 4 260033 156426

**Packaging**  
 Blister 8 pcs/pack  
 Inner Box 12 packs/box  
 Outer Carton 72 packs/carton

**Gross Weight:** 6.6 kg  
**Volume:** 0.0132 cbm

**Dimensions**  
 Blister (mm) 84(W) x 165(H) x 11(D)  
 Inner Box (mm) 200(L) x 84(W) x 90(H)  
 Outer Carton (cm) 30.0(L) x 22.0(W) x 20.0(H)



**6F22-BP1G**  
**9V**  
 4 260033 156341

**Packaging**  
 Blister 1 pcs/pack  
 Inner Box 12 packs/box  
 Outer Carton 240 packs/carton

**Gross Weight:** 11.4 kg  
**Volume:** 0.0310 cbm

**Dimensions**  
 Blister (mm) 84(W) x 114(H) x 18(D)  
 Inner Box (mm) 123(L) x 117(W) x 86(H)  
 Outer Carton (cm) 45.0(L) x 27.0(W) x 25.5(H)



**6F22-BP2G**  
**9V**  
 4 260033 156365

**Packaging**  
 Blister 2 pcs/pack  
 Inner Box 12 packs/box  
 Outer Carton 192 packs/carton

**Gross Weight:** 18.3 kg  
**Volume:** 0.0310 cbm

**Dimensions**  
 Blister (mm) 84(W) x 114(H) x 18(D)  
 Inner Box (mm) 123(L) x 117(W) x 86(H)  
 Outer Carton (cm) 36.2(L) x 26.3(W) x 25.8(H)

# Batteries ▶ Super Heavy Duty



## 3R12-BP1G

**4.5V**



Packaging	4 260033 156372	
Blister	1 pcs/pack	Gross Weight: 15.4 kg
Inner Box	6 packs/box	Volume: 0.0290cbm
Outer Carton	144 packs/carton	

### Dimensions

Blister (mm)	84(W) x 114(H) x 23(D)
Inner Box (mm)	160(L) x 75(W) x 86(H)
Outer Carton (cm)	33.5(L) x 31.5(W) x 27.5(H)



## R20P-SP2G

**1.5V D**



Packaging	4 260033 156433	
Shrink	2 pcs/pack	Gross Weight: 17.5 kg
Inner Box	6 packs/box	Volume: 0.0169 cbm
Outer Carton	96 packs/carton	

### Dimensions

Shrink (mm)	66(W) x 61(H) x 33(D)
Inner Box (mm)	137(L) x 103(W) x 68(H)
Outer Carton (cm)	28.5(L) x 22.0(W) x 27.0(H)



## R14P-SP2G

**1.5V C**



Packaging	4 260033 156440	
Shrink	2 pcs/pack	Gross Weight: 13.2 kg
Inner Box	6 packs/box	Volume: 0.0129 cbm
Outer Carton	144 packs/carton	

### Dimensions

Shrink (mm)	52(W) x 50(H) x 26(D)
Inner Box (mm)	104(L) x 78(W) x 50(H)
Outer Carton (cm)	25.5(L) x 23.0(W) x 22.0(H)



## R6P-SP4G

**1.5V AA**



Packaging	4 260033 156457	
Shrink	4 pcs/pack	Gross Weight: 14.7 kg
Inner Box	15 packs/box	Volume: 0.0127cbm
Outer Carton	240 packs/carton	

### Dimensions

Shrink (mm)	56(W) x 50(H) x 14(D)
Inner Box (mm)	174(L) x 72(W) x 50(H)
Outer Carton (cm)	30.5(L) x 22.0(W) x 19.0(H)



## R6P-SP2G

**1.5V AA**



Packaging	4 260033 156464	
Shrink	2 pcs/pack	Gross Weight: 15.5 kg
Inner Box	30 packs/box	Volume: 0.0127cbm
Outer Carton	480 packs/carton	

### Dimensions

Shrink (mm)	28(W) x 50(H) x 14(D)
Inner Box (mm)	113(L) x 72(W) x 50(H)
Outer Carton (cm)	30.5(L) x 22.0(W) x 19.0(H)



## R03P-SP4G

**1.5V AAA**



Packaging	4 260033 156471	
Shrink	4 pcs/pack	Gross Weight: 10.0 kg
Inner Box	15 packs/box	Volume: 0.0083 cbm
Outer Carton	300 packs/carton	

### Dimensions

Shrink (mm)	40(W) x 44.5(H) x 10(D)
Inner Box (mm)	125(L) x 52(W) x 45(H)
Outer Carton (cm)	28.5(L) x 20.0(W) x 14.5(H)



## R03P-SP2G

**1.5V AAA**



Packaging	4 260033 156488	
Shrink	2 pcs/pack	Gross Weight: 9.5 kg
Inner Box	30 packs/box	Volume: 0.0083 cbm
Outer Carton	600 packs/carton	

### Dimensions

Shrink (mm)	40(W) x 44.5(H) x 10(D)
Inner Box (mm)	83(L) x 52(W) x 45(H)
Outer Carton (cm)	28.5(L) x 20.0(W) x 14.5(H)



## 6F22-SP1G

**9V**



Packaging	4 260033 156495	
Shrink	1 pcs/pack	Gross Weight: 19.0 kg
Inner Box	12 packs/box	Volume: 0.0144 cbm
Outer Carton	480 packs/carton	

### Dimensions

Shrink (mm)	25.5(W) x 48.5(H) x 17.5 (D)
Inner Box (mm)	105(L) x 52(W) x 50(H)
Outer Carton (cm)	29.0(L) x 22.5(W) x 22.0(H)



## 3R12-SP1G

**4.5V**



Packaging	4 260033 156501	
Shrink	1 pcs/pack	Gross Weight: 16.6 kg
Inner Box	12 packs/box	Volume: 0.0188 cbm
Outer Carton	144 packs/carton	

### Dimensions

Shrink (mm)	62(W) x 65.5 (H) x 22 (D)
Inner Box (mm)	188(L) x 90(W) x 65(H)
Outer Carton (cm)	39.0(L) x 21.0(W) x 23.0(H)



## 4R25-SP1G

6V



4 260033 156211

<b>Packaging</b>		
Shrink	1 pcs/pack	<b>Gross Weight:</b> 6.7 kg
Inner Box	6 packs/box	<b>Volume:</b> 0.0090 cbm
Outer Carton	12 packs/carton	

<b>Dimensions</b>		
Shrink (mm)	68.5(W) x 68.5(H) x 115 (D)	
Inner Box (mm)	205(L) x 135(W) x 120(H)	
Outer Carton (cm)	29.0(L) x 22.0(W) x 14.0(H)	



## FPG-GB40



4 260033 150905

<b>Packaging</b>		
24 x R6P+12 x R03P+4 x R14P+		<b>Gross Weight:</b> 13.0 kg
1 x SL3013(Blue 3LR44)		<b>Volume:</b> 0.0223 cbm
Outer Carton	18 boxes/carton	

Box (mm)	132(B) x 126(T) x 54(H)	
Outer Carton (cm)	40.0 (L) x 28.0(W) x 19.5(H)	



## R6P-SP8G

1.5V AA



4 260216 451188

<b>Packaging</b>		
Shrink	8 pcs/pack	<b>Gross Weight:</b> 14.7 kg
Inner Box	20 packs/box	<b>Volume:</b> 0.0147 cbm
Outer Carton	6 boxes/carton	

<b>Dimensions</b>		
Inner Box (mm)	150(L) x 118(W) x 110(H)	
Outer Carton (cm)	34.5(L) x 25.0(W) x 17.0(H)	



## R03P-SP8G

1.5V AAA



4 260216 451171

<b>Packaging</b>		
Shrink	8 pcs/pack	<b>Gross Weight:</b> 15.3 kg
Inner Box	40 packs/box	<b>Volume:</b> 0.0141 cbm
Outer Carton	6 boxes/carton	

<b>Dimensions</b>		
Inner Box (mm)	170(L) x 110(W) x 100(H)	
Outer Carton (cm)	31.5(L) x 23.5(W) x 19.0(H)	



## R6P-SP12G

1.5V AA



4 260033 156266

<b>Packaging</b>		
Shrink	12 pcs/pack	<b>Gross Weight:</b> 16.5 kg
Inner Box	6 packs/box	<b>Volume:</b> 0.0127 cbm
Outer Carton	8 boxes/carton	

<b>Dimensions</b>		
Inner Box (mm)	175(L) x 150(W) x 110(H)	
Outer Carton (cm)	31.5(L) x 19.0(W) x 24.0(H)	



## R03P-SP12G

1.5V AAA



4 260216 451195

<b>Packaging</b>		
Shrink	12 pcs/pack	<b>Gross Weight:</b> 14.8 kg
Inner Box	20 packs/box	<b>Volume:</b> 0.0143 cbm
Outer Carton	8 boxes/carton	

<b>Dimensions</b>		
Inner Box (mm)	130(L) x 110(W) x 100(H)	
Outer Carton (cm)	27.5(L) x 23.5(W) x 22.0(H)	



## R6P-PB24G

1.5V AA



4 260033 157454

<b>Packaging</b>		
Box	24 pcs/pack	<b>Gross Weight:</b> 18.3 kg
Outer Carton	30 packs/carton	<b>Volume:</b> 0.0178 cbm

<b>Dimensions</b>		
Plastic box (mm)	98(L) x 75(W) x 50(H)	
Outer Carton (cm)	42.5(L) x 22(W) x 19(H)	



## R03P-PB24G

1.5V AAA



4 260033 157447

<b>Packaging</b>		
Box	24 pcs/pack	<b>Gross Weight:</b> 9.0 kg
Outer Carton	30 packs/carton	<b>Volume:</b> 0.0107 cbm

<b>Dimensions</b>		
Plastic box (mm)	80(L) x 60(W) x 45(H)	
Outer Carton (cm)	34.5(L) x 18.5(W) x 17.0(H)	

# Batteries ▶ Lithium



## Photo Lithium Batteries

Camelion Photo batteries are ideal for a wide range of analog cameras.



### CR123A-BP1

3V



#### Packaging

Blister 1 pcs/pack  
Inner Box 10 packs/box  
Outer Carton 200 packs/carton

Gross Weight: 5.5 kg  
Volume: 0.0243 cbm

#### Dimensions

Blister (mm) 84(W) x 114(H) x 17.5(D)  
Inner Box (mm) 118(L) x 95(W) x 85(H)  
Outer Carton (cm) 45.0(L) x 25.0(W) x 21.5(H)



### CR123A-BP2

3V



#### Packaging

Blister 2 pcs/pack  
Inner Box 10 packs/box  
Outer Carton 200 packs/carton

Gross Weight: 8.6 kg  
Volume: 0.0242 cbm

#### Dimensions

Blister (mm) 84(W) x 114(H) x 18(D)  
Inner Box (mm) 118(L) x 95(W) x 85(H)  
Outer Carton (cm) 45.0(L) x 25.0(W) x 21.5(H)



### CR-P2-BP1

6V



#### Packaging

Blister 1 pcs/pack  
Inner Box 10 packs/box  
Outer Carton 200 packs/carton

Gross Weight: 10.0 kg  
Volume: 0.0265 cbm

#### Dimensions

Blister (mm) 84(W) x 114(H) x 20.5(D)  
Inner Box (mm) 118(L) x 105(W) x 85(H)  
Outer Carton (cm) 45.0(L) x 25.0(W) x 23.5(H)



### 2CR5-BP1

6V



#### Packaging

Blister 1 pcs/pack  
Inner Box 10 packs/box  
Outer Carton 200 packs/carton

Gross Weight: 10.0 kg  
Volume: 0.0265 cbm

#### Dimensions

Blister (mm) 84(W) x 114(H) x 18(D)  
Inner Box (mm) 118(L) x 105(W) x 85(H)  
Outer Carton (cm) 45.0(L) x 25.0(W) x 23.5(H)



### CR2-BP1

3V



#### Packaging

Blister 1 pcs/pack  
Inner Box 10 packs/box  
Outer Carton 200 packs/carton

Gross Weight: 4.5 kg  
Volume: 0.0215 cbm

#### Dimensions

Blister (mm) 84(W) x 114(H) x 16.5(D)  
Inner Box (mm) 118(L) x 85(W) x 85(H)  
Outer Carton (cm) 45.0(L) x 25.0(W) x 19.0(H)



► **Electronic Button Cells**

## Electronic Button Cells

Camelion Electronic Button Cells provide stable energy for small electronic devices and are available in lithium, alkaline, silver oxide and zinc air chemistries, depending upon voltage and size requirements of your equipment. They are suitable for car keys, calculators, laser points, hearing aids and many other electronic gadgets.



## Electronics Lithium 3V



ITEM	EAN	PACKAGING WxHxD(mm)	INNER BOX LxWxH(mm)	SHIPPING CARTON LxWxH(cm)	G.W.(KG)	VOLUME(CBM)
CR1216-BP1	4260033152831	56 x 92 x 3 1 PC / BLISTER	98 x 37 x 58 10 PACKS	45.5 x 31.5 x 31.5 1800 PACKS	9.5	0.0451
CR1220-BP1	4260033152824				8.0	
CR1225-BP1	4260033152817				8.0	
CR1616-BP1	4260033152800				8.0	
CR1620-BP1	4260033152794				8.5	
CR1632-BP1	4260033152923				10.4	
CR2016-BP1	4260033152787				9.5	
CR2025-BP1	4260033152770				11.0	
CR2032-BP1	4260033152763				12.0	
CR2320-BP1	4260033152756				11.5	
CR2325-BP1	4260033152848				12.0	
CR2330-BP1	4260033152749				13.0	
CR2430-BP1	4260033152732				13.5	
CR2450-BP1	4260033152725				17.5	
CR2477-BP1	4260216455353				17.72	
CR927-BP1	4260216452475				14.0	
CR1216-BP5	4260033152718	55x 190 x 3 5 PCS / BLISTER	195 x 90 x 58 30 PACKS	29.0 x 22.0 x 26.0 360 PACKS	4.5	0.0165
CR1220-BP5	4260033152701				4.5	
CR1225-BP5	4260033152695				5.0	
CR1616-BP5	4260033152688				5.5	
CR1620-BP5	4260033152671				5.5	
CR1632-BP5	4260216455797				6.5	
CR2016-BP5	4260033152664				8.0	
CR2025-BP5	4260033152657				9.0	
CR2032-BP5	4260033152640				5.5	
CR2430-BP5	4260216455803				12.2	
CR2450-BP5	4260216455810	16.7				
CRV001-BP6	4260216456145	125x114x6.5 6 PCS / BLISTER	138 x 85 x 127 24 PACKS	29.5 x 27.5 x 28.0 288 PACKS	8.0	0.0227



## Batteries ▶ Electronic Button Cells

### Electronics Alkaline

1.5V



ITEM(0%Hg)	EAN	PACKAGING WxHxD(mm)	INNER BOX LxWxH(mm)	SHIPPING CARTON LxWxH(cm)	G. W. (KG)	VOLUME (CBM)
AG1-BP2(0%Hg)	4260216454783	56 x 92 x 5 2 PC / BLISTER	95 x 63 x 58 20 PACKS	39.5 x 30.5 x 31.5 1800 PACKS	7.0	0.0379
AG2-BP2(0%Hg)	4260216454790				7.8	
AG3-BP2(0%Hg)	4260216454806				8.0	
AG4-BP2(0%Hg)	4260216454622				7.0	
AG5-BP2(0%Hg)	4260216454813	56 x 92 x 7 2 PC / BLISTER	98 x 73 x 58 20 PACKS	45.5 x 31.5 x 31.5 1800 PACKS	9.0	0.0451
AG6-BP2(0%Hg)	4260216454820	56 x 92 x 5 2 PC / BLISTER	95 x 63 x 58 20 PACKS	39.5 x 30.5 x 31.5 1800 PACKS	8.0	0.0379
AG7-BP2(0%Hg)	4260216454837				8.5	
AG8-BP2(0%Hg)	4260216454844				9.0	
AG9-BP2(0%Hg)	4260216454851				9.0	
AG10-BP2(0%Hg)	4260216454608				10.0	
AG11-BP2(0%Hg)	4260216454868				7.0	
AG12-BP2(0%Hg)	4260216454875	56 x 92 x 7 2 PC / BLISTER	98 x 73 x 58 20 PACKS	45.5 x 31.5 x 31.5 1800 PACKS	11.0	0.0451
AG13-BP2(0%Hg)	4260216454615	13.0				
625A-BP1(0%Hg)	4260216454882	56 x 92 x 7 1 PC / BLISTER	146 x 98 x 58 40 PACKS	45.5 x 31.5 x 31.5 1800 PACKS	18.0	0.0451
AG0-BP10(0%Hg)	4260216454899	50x 160 x 5 10 PCS / BLISTER	170 x 40 x 52 20 PACKS	50.0 x 20.0 x 20.0 360 PACKS	4.0	0.0198
AG1-BP10(0%Hg)	4260216454905				4.0	
AG2-BP10(0%Hg)	4260216454912				4.5	
AG3-BP10(0%Hg)	4260216454929				5.0	
AG4-BP10(0%Hg)	4260216454400				4.0	
AG5-BP10(0%Hg)	4260216454936				6.5	
AG6-BP10(0%Hg)	4260216454943				5.0	
AG7-BP10(0%Hg)	4260216454950				5.5	
AG8-BP10(0%Hg)	4260216454967				6.0	
AG9-BP10(0%Hg)	4260216454974				6.0	
AG10-BP10(0%Hg)	4260216454981				7.0	
AG11-BP10(0%Hg)	4260216454998				4.0	
AG12-BP10(0%Hg)	4260216455001				8.7	
AG13-BP10(0%Hg)	4260216455018	10.0				



### Industrial Classifications

AG0	LR521	G0			379
AG1	LR621	G1	LR60	164	364
AG2	LR726	G2	LR59	196	396
AG3	LR41	G3	LR41	192	392
AG4	LR626	G4	LR66	177	377
AG5	LR754	G5	LR48	193	393
AG6	LR921	G6	LR69	171	371
AG7	LR926	G7	LR57	195	395
AG8	LR1120	G8	LR55	191	391
AG9	LR936	G9	LR45	194	394
AG10	LR1130	G10	LR54	189	389
AG11	LR721	G11	LR58	162	362
AG12	LR43	G12	LR43	186	386
AG13	LR44	G13	LR44	A76	357

## Remote Control Batteries

6V/12V



ITEM(0% Hg)	EAN	Voltage (V)	PACKAGING WxHxD(mm)	INNER BOX LxWxH(mm)	SHIPPING CARTON LxWxH(cm)	G.W. (KG)	VOLUME (CBM)
A11-BP1(0%Hg)	4260216455049	6V	56 x 92 x 10 1 PC / BLISTER	125 x 95 x 58 20 PACKS	39.5 x 30.5 x 31.5 900 PACKS	7.6	0.0380
A23-BP1(0%Hg)	4260216455056	12V				8.6	
A27-BP1(0%Hg)	4260216455063	12V				8.0	
LR32A-BP1(0%Hg)	4260216455070	9V				6.0	
A23-BP5(0%Hg)	4260216455087	12V	50 x 160 x 10 5 PCS / BLISTER	170 x 65 x 52 10 PACKS	42.0 x 36.0 x 18.0 360 PACKS	18.0	0.0273
A27-BP5(0%Hg)	4260216455094	12V				12.0	

### 4LR44-BP1C(0%Hg)



**6V**

4 260216 455025

**Packaging**

**Blister** 1 pcs/pack

**Inner Box** 20 packs/box

**Outer Carton** 900 packs/carton

**Gross Weight:** 15.0 kg

**Volume:** 0.0451 cbm

**Dimensions**

**Blister (mm)** 56(W)x 92(H) x (D)

**Inner Box (mm)** 145(L)x 95(W) x 58(H)

**Outer Carton (cm)** 45.5(L)x 31.5(W) x 31.5(H)

### 4LR44-BP5(0%Hg)



**6V**

4 260216 455827

**Packaging**

**Blister** 5 pcs/pack

**Inner Box** 6 packs/box

**Outer Carton** 192 packs/carton

**Gross Weight:** 13.2 kg

**Volume:** 0.0150 cbm

**Dimensions**

**Blister (mm)** 50(W) x 160(H) x (D)

**Inner Box (mm)** 170(L) x 78(W) x 52(H)

**Outer Carton (cm)** 33.5(L) x 19.0(W) x 23.5(H)

### 4LR43-BP1(0%Hg)



**6V**

4 260216 456619

**Packaging**

**Blister** 1 pcs/pack

**Inner Box** 20 packs/box

**Outer Carton** 900 packs/carton

**Gross Weight:** 15.0 kg

**Volume:** 0.0451 cbm

**Dimensions**

**Blister (mm)** 56(W)x 92(H) x (D)

**Inner Box (mm)** 145(L)x 95(W) x 58(H)

**Outer Carton (cm)** 45.5(L)x 31.5(W) x 31.5(H)

## Industrial Classifications

SG0	SR521	G0	SR63	379
SG1	SR621	G1	SR60	364
SG2	SR726	G2	SR59	396
SG3	SR41	G3	SR41	392
SG4	SR626	G4	SR66	377
SG5	SR754	G5	SR48	393
SG6	SR921	G6	SR69	371
SG7	SR926	G7	SR57	395
SG8	SR1120	G8	SR55	391
SG9	SR936	G9	SR45	394
SG10	SR1130	G10	SR54	389
SG11	SR721	G11	SR58	362
SG12	SR43	G12	SR43	386
SG13	SR44	G13	SR44	357

# Batteries ▶ Electronic Button Cells

## Electronics Silver Oxide 1.55V



ITEM(0% Hg)	EAN	PACKAGING WxHxD(mm)	INNER BOX LxWxH(mm)	SHIPPING CARTON LxWxH(cm)	G. W. (KG)	VOLUME (CBM)
SR41-BP1 (0%Hg)	4260216455117	55x 92 x 5 1 PC / BLISTER	145 x 95 x 58 40 PACKS	45.5 x 31.5 x 31.5 1800 PACKS	8.5	0.0451
SR43-BP1 (0%Hg)	4260216455124				10.5	
SR44-BP1 (0%Hg)	4260216455131				11.5	
SR54-BP1 (0%Hg)	4260216455148				9.5	
SR57-BP1 (0%Hg)	4260216455155				8.5	
SR58-BP1 (0%Hg)	4260216455162				8	
SR59-BP1 (0%Hg)	4260216455179				8	
SR60-BP1 (0%Hg)	4260216455186				8	
SR63-BP1 (0%Hg)	4260216455193				7.5	
SR66-BP1 (0%Hg)	4260216455209				8	
SR69-BP1 (0%Hg)	4260216455216	9.5				
SR41-BP5(0%Hg)	4260216455223	55x 190 x 5 5 PCS / BLISTER	195 x 90 x 58 20 PACKS	37.0 x 21.7 x 29.5 360 PACKS	4.5	0.0237
SR43-BP5(0%Hg)	4260216455230				6.5	
SR44-BP5(0%Hg)	4260216455247				7.5	
SR54-BP5(0%Hg)	4260216455254				5.5	
SR57-BP5(0%Hg)	4260216455261				4.5	
SR58-BP5(0%Hg)	4260216455278				4	
SR59-BP5(0%Hg)	4260216455285				4	
SR60-BP5(0%Hg)	4260216455292				4	
SR63-BP5(0%Hg)	4260216455308				3.5	
SR66-BP5(0%Hg)	4260216455315				4	
SR69-BP5(0%Hg)	4260216455322	5.5				

### 4SR44-BP1C(0% Hg)



**6.2V**



#### Packaging

**Blister** 1 pcs/pack  
**Inner Box** 20 packs/box  
**Outer Carton** 900 packs/carton

**Gross Weight:**  
15.0 kg  
**Volume:**  
0.0451 cbm

#### Dimensions

**Blister (mm)** 55(W)x 92(H) x 5(D)  
**Inner Box (mm)** 145(L)x 95(W) x 58(H)  
**Outer Carton (cm)** 45.5(L)x 31.5(W) x 31.5(H)

### 4SR44-Bulk

**6.2V**



#### Packaging

**Inner Box** 32 packs/box  
**Outer Carton** 1280 packs/carton

**Gross Weight:**  
14.6 kg  
**Volume:**  
0.0104 cbm

#### Dimensions

**Inner Box (mm)** 102(L)x 52(W) x 30(H)  
**Outer Carton (cm)** 24(L)x 23.5(W) x 18.5(H)

## Zinc Air 1.4V

Camelion Hearing Aid batteries are light and reliable. They are conveniently packaged to make them easy to use.



ITEM	EAN	WxHxD (mm)	PACKAGING	WxHxD (mm)	INNER BOX	WxHxD (mm)	INNER CARTON	WxHxD (cm)	SHIPPING CARTON	G. W. (KG)	VOLUME (CBM)
A13-BP6(0%Hg)	4260216454417	48 x 90 x 6.5	6PCS/Blister	92 x42 x 50	10 Packs	245 x 120 x 130	100 Packs	62 x 26 x 15	500 Packs	6.5	0.0242
A10-BP6(0%Hg)	4260216454486	48 x 90 x 4.5	6PCS/Blister	92 x32 x 50	10 Packs	195 x 120 x 130	100 Packs	62 x 21 x 15	500 Packs	6.0	0.0196
A675-BP6(0%Hg)	4260216454493	48 x 90 x 6.5	6PCS/Blister	92 x42 x 50	10 Packs	245 x 120 x 130	100 Packs	62 x 26 x 15	500 Packs	9.5	0.0242
A312-BP6(0%Hg)	4260216454509	48 x 90 x 4.5	6PCS/Blister	92 x32 x 50	10 Packs	195 x 120 x 130	100 Packs	62 x 21 x 15	500 Packs	6.5	0.0196

## Battery Adapter



For Rechargeable & Non-Rechargeable Batteries



### Warning:

When using two or more adapters together, avoid mixing new and used batteries, batteries with different charge levels or different types and brands. Don't mix adapters with actual D batteries in the device. Please insert the AA batteries into the adapter correctly. Remove battery after use, or when not in use. Store adapter separately from battery. Do not recharge battery while in the adapter.

## Battery Case

### Main Features

- Durable plastic case holds up to 4 AA/AAA batteries.
- Keep your batteries together and safe.

### Directions

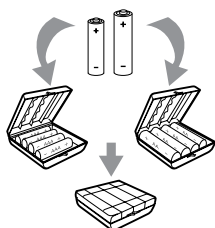

## Battery Tester



### BT-0503

Tests AA, AAA, C, D, 9V and some models of button cell

#### MAIN FEATURES

- Quickly determines if battery needs charging or replacing
- On the spot testing – just insert and check LED
- Compact & light

- Insert battery: Observe polarity

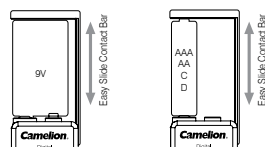

- Check LED indicator: If LED fluctuates press slightly

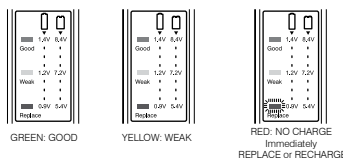

### BT-0503



#### Packaging

Blister	1 pcs/pack	Gross Weight:	8.7 kg
Inner Box	60 packs/box	Volume:	0.0388 cbm
Outer Carton	240 packs/carton		

#### Dimensions

Blister (mm)	65(W)x 154(H) x 16(D)
Inner Box (cm)	44(L)x 11.5(W) x 16.5(H)
Outer Carton (cm)	45(L)x 34.5(W) x 25(H)



### BT-0507

Tests AA, AAA, C, D, 9V and some models of button cell

#### MAIN FEATURES

- Easy to Observe Pointer for indicates real time battery conditions.
- Three Color Scale for to easily check reading the power conditions.
- Wide Usage can test almost all 1.5V and 9V batteries.
- Rotatable Test Arm easily adapts to different battery types.
- Portable



### BT-0507

















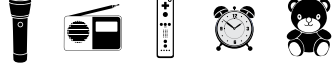

#### Packaging

Blister	1 pcs/pack	Gross Weight:	4.8 kg
Inner Box	12 packs/box	Volume:	0.0293 cbm
Outer Carton	96 packs/carton		

#### Dimensions

Blister (mm)	130(W)x 90(H) x 24(D)
Inner Box (cm)	17(L)x 16(W) x 10.5(H)
Outer Carton (cm)	36(L)x 34(W) x 24(H)

# Batteries ▶ Battery Selection Chart

Lithium P7 Batteries		
Digi Alkaline Batteries		
Plus Alkaline Batteries		
Super Heavy Duty Batteries		
Photo Lithium Batteries		
9V Lithium Battery		
Micro Batteries: Lithium		
Micro Batteries: Alkaline		
Hearing Aid Zinc Air		

**Please Note:**

These are suggested recommendations only. For the most accurate information please refer to your device manufacturer's manual. Camelion is not responsible for accidents resulting from the use of this information

## Specifications

	Lithium P7		Digi Alkaline		Plus Alkaline							Super Heavy Duty							
	FR6	FR03	LR6	LR03	LR20	LR14	LR6	LR03	LR61	6LF22**	3LR12	R6	R03	R20	R14	6F22**	3R12*	4R25**	R10
<b>Nominal Voltage(V)</b>	1.5	1.5	1.5	1.5	1.5	1.5	1.5	1.5	1.5	9	4.5	1.5	1.5	1.5	1.5	9	4.5	6	1.5
<b>Average Capacity(mAh)</b>	2800	1100	2800	1100	18000	8500	2800	1100	600	190**	2700*	950	460	5600	2400	450	1700	7000	500

20+ -2°C, Rated capacity at 25 mA continuous drain, to 0.8V  
 \* 20+ -2°C, Rated capacity at 25 mA continuous drain, to 2.7V  
 \*\* 20+ -2°C, Rated capacity at 25 mA continuous drain, to 4.8V



# Rechargeable

---

# Battery Chargers

---



# Chargers ▶ Ultra Fast Charger



## BC-0907

Charges:

1-4 × AA

1-4 × AAA

Ni-MH



AC Adapter



Car Adapter



L00406A

## SPECIFICATIONS

### AC To DC Adapter

Input: 100-240V ~ 50/60Hz

Output : 12V =

### Car Plug

Output : 12V =

### Charger

Charging Currents

4x(1.4V = 2200 mA) AA Size

4x(1.4V = 800 mA) AAA Size

## MAIN FEATURES

- **4 Independent Charging Channels**
- **6 Level Charge Protection**
  - -ΔV Cut-Off
  - Timer Control Protection (1.5 hours)
  - Over Temperature Protection
  - Reverse Polarity Protection
  - Over Current and Short Circuit Protection
  - Defective and Non-rechargeable Battery Detection
- **Low Current Leakage** Minimizes loss of capacity and maintains battery charge by controlling current leakage.
- **Trickle Charge** maintains battery charge.
- **World Voltage Switch Adapter**
- **Battery Refresh** reduces memory effect and enables full discharge for long battery life.
- **Car Plug Adapter**
- **Pulse Charging Technology** for fast, efficient charging.
- **Easy To Read LCD Display** shows Charging Progress, Defective Battery, Battery Refresh Features.



## CHARGING TIMES

Type of Battery	Charging Times (Appr.)
Ni-MH AA 2700 mAh	80min
Ni-MH AA 2000 mAh	60min
Ni-MH AA 1500 mAh	50min
Ni-MH AAA800 mAh	70min

## AVAILABLE COLORS

Silver
  Black

## BARCODE



## PACKAGING

UK



Blister		
Plug:	TUV	UK
Weight(g)	272	278
Dimensions (W) x (H) x (D) (mm)	112 x 188 x 67	112 x 188 x 67
Inner Carton		
Packs / Inner ctn	8	8
Net Weight(kg)	2.1	2.1
Gross Weight(kg)	2.3	2.5
Dimensions (L)x (W) x (H) (cm)	33 x 27 x 13.8	43.5 x 23 x 13.8
Outer Carton		
Packs / Carton	16	32
Net Weight(kg)	4.3	8.8
Gross Weight(kg)	5	10.45
Dimensions (L)x (W) x (H) (cm)	34.5 x 28.5 x 30	47.5 x 45 x 30
Volume(M <sup>3</sup> )	0.0295	0.0641

# Chargers ▶ Super Fast Charger

## BC-0905A

### Charges:

1 or 4 × AA

1 or 4 × AAA

Ni-MH



Flip plug

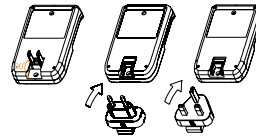

\*Different plug models for different countries

## SPECIFICATIONS

Input: 100-240V~50/60Hz

Output: AA: 1000mA (1- 2 pcs),  
500mA (3-4 pcs)

AAA: 600mA (1- 2 pcs),  
300mA (3-4 pcs)

## MAIN FEATURES

- **4 Independent Charging Channels**
- **6 Level Charge Protections**
  - -ΔV Cut Off
  - Timer Control Protection  
3.5 hours(1-2cells) or 7 hours(3-4cells)
  - Over Temperature Protection
  - Reverse Polarity Protection
  - Over Current and Short Circuit Protection
  - Defective and Non-rechargeable Battery Detection
- **Trickle Charge**
- **Switch and Match Plugs**
- **LED Indicators**

<b>Red</b>	Charging
<b>Flashing</b>	Defective or non-rechargeable batteries / Short circuit
<b>Green</b>	Fully charged / trickle

## CHARGING TIMES

Type of Battery	Charging Times (Appr.)	
	1-2 Cells	3-4 Cells
Ni-MH AA 2700 mAh	3 h	6 h
Ni-MH AA 2000 mAh	2.5 h	4.5 h
Ni-MH AA 1500 mAh	2 h	3.5 h
Ni-MH AAA 800 mAh	100 min	3 h
Ni-Cd AA 1000 mAh	70 min	2 h
Ni-Cd AAA 300 mAh	40 min	70 min

## AVAILABLE COLORS

Black

## BARCODE



## PACKAGING



UK

Blister		
Plug:	TUV	UK
<b>Weight(g)</b>	153	144
<b>Dimensions(W)x(H)x(D)(mm)</b>	125x205x70	125x205x70
Inner Carton		
<b>Packs / Inner ctn</b>	16	16
<b>Net Weight(kg)</b>	2.45	2.3
<b>Gross Weight(kg)</b>	3	3
<b>Dimensions(L)x(W)x(H)(cm)</b>	48.5x22.5x27	48.5x22.5x27
Outer Carton		
<b>Packs / Carton</b>	32	32
<b>Net Weight(kg)</b>	4.9	4.8
<b>Gross Weight(kg)</b>	6.4	6.3
<b>Dimensions(L)x(W)x(H)(cm)</b>	51x 47 x 29	50 x 47 x 29
<b>Volume(cbm)</b>	0.0682	0.0682



## ► Fast Chargers

### BC-1010B

#### Charges:

2 or 4 × AA

2 or 4 × AAA

Ni-MH



\*Different plug models for different countries



### SPECIFICATIONS

Input: 100-240V ~ 50/60Hz 4W Max.  
Output: 2 x (2.8V = 200mA) AA/AAA Size

### MAIN FEATURES

- 2 Independent Charging Channels
- Reverse Polarity Protection
- Worldwide Voltage
- 2 LED Indicators

Red	Charging or charge completed
-----	------------------------------

### CHARGING TIMES

Type of Battery	Charging Times (Appr.)
Ni-MH AA 2700 mAh	17 h
Ni-MH AA 2000 mAh	14 h
Ni-MH AA 1500 mAh	11 h
Ni-MH AAA 800 mAh	5 h
Ni-Cd AA 1000 mAh	6 h
Ni-Cd AAA 300 mAh	2 h

### AVAILABLE COLORS

 Black

### BARCODE



### PACKAGING





Blister	
Plug:	TUV
Weight(g)	118.2
Dimensions(W)x(H)x(D)(mm)	125 x 204 x 76
Inner Carton	
Packs / Inner ctn	8
Net Weight(kg)	0.95
Gross Weight(kg)	1.3
Dimensions(L)x(W)x(H)(cm)	49.5 x 23.5 x 14
Outer Carton	
Packs / Carton	32
Net Weight(kg)	3.78
Gross Weight(kg)	5.5
Dimensions(L)x(W)x(H)(cm)	50.5 x 48.5 x 30
Volume(cbm)	0.0735

# Chargers ▶ Fast Chargers

## BC-1002F

### Charges:

1 - 4 ×   
1 - 4 × 

**Ni-MH**



USB Cable



### SPECIFICATIONS

Input: 5V  $\overline{=}$  1A  
Output: 4 x (1.4V  $\overline{=}$  500mA) AA Size  
4 x (1.4V  $\overline{=}$  250mA) AAA Size

### MAIN FEATURES

- 4 Independent Charging Channels
- Trickle charging function
- Easy to Monitor LED Charge Indicators
- 5-Level Charge Protections:
  - $\Delta$ V cut off
  - Timer Control Protection(6hours)
  - Reverse Polarity Protection
  - Short Circuit Protection
  - Defective and Non-rechargeable battery detection

<b>Red on</b>	Charging
<b>Green</b>	Fully charged / Trickle
<b>Red flashing</b>	Defective or non-rechargeable batteries / short circuit

### CHARGING TIMES

Type of Battery	Charging Times (Appr.)
Ni-MH AA 2500 mAh	6 h
Ni-MH AA 2000 mAh	5 h
Ni-MH AA 1500 mAh	3.5 h
Ni-MH AAA 1000 mAh	5 h
Ni-MH AAA 800 mAh	4 h
Ni-MH AAA 600 mAh	3 h

### AVAILABLE COLORS

 white

### BARCODE



### PACKAGING



Blister	
Plug:	/
Weight(g)	196
Dimensions (W) x (H) x (D) (mm)	125 x 205 x 70
Inner Carton	
Packs / Inner ctn	16
Net Weight(kg)	3.14
Gross Weight(kg)	3.68
Dimensions (L)x (W) x (H) (cm)	46 x 24.5 x 27
Outer Carton	
Packs / Carton	32
Net Weight(kg)	6.28
Gross Weight(kg)	7.76
Dimensions (L)x (W) x (H) (cm)	51x 47 x 29
Volume(M <sup>3</sup> )	0.0695

## BC-1012

### Charges:

1-4 × AA  
1-4 × AAA

Ni-MH



### SPECIFICATIONS

Input: 100-240V ~ 50/60Hz

Output: 1.4V  $\overline{\text{---}}$

AA : 400 mA (1~2 Pcs) ; 260 mA (3 Pcs) ; 200 mA (4 Pcs)

AAA : 200 mA (1~2 Pcs) ; 130 mA (3 Pcs) ; 100 mA (4 Pcs)

### MAIN FEATURES

- **Charges up to 4 AA/AAA Ni-MH/Ni-Cd Batteries**
- **Multi-band LCD Monitor** for easy to read status of the charger
- **4 Independent Charging Channels** Four charging slots support any AA/AAA battery combination.
- **Reverse Polarity Protection** A special shell structure prevents incorrect battery insertion, helping avoid damage to the battery and charger.
- **Pulse Charging Technology** Uses a precisely regulated current to maximize the charging efficiency, control battery temperature and increase battery life.
- **Micro Control Unit (MCU)** The MCU enables intelligent charging by automatically identifying non-rechargeable batteries, offering multiple levels of protection including negative delta V ( $-\Delta V$ ), voltage protection, safety charging cut-offs.
- **Over Current Protection** Charger maintains a constant charging current during the charging cycle.
- **Short Circuit Protection** The MCU detects attempts to charge shorted batteries or directly short the output channels, in which case the LCD indicator flashes.
- **Timer Control** The charger automatically detects the correct charging time, cuts off the charger automatically (1-2 batteries 6 hours), (3 batteries 9 hours), (4 batteries 12 hours).

### CHARGING TIMES

Type of Battery	Charging Times (Appr.)		
	1-2 Akku	3 Akkus	4 Akkus
Ni-MH AA 2500 mAh	6 h	9 h	12 h
Ni-MH AA 2000 mAh	6 h	9 h	12 h
Ni-MH AAA 1000 mAh	6 h	9 h	12 h
Ni-MH AAA 800 mAh	5 h	8.5 h	11 h

### AVAILABLE COLORS

white

### BARCODE

BC-1012-2H23AR/2H800AR-DB



4 260216 453199

### PACKAGING



Blister	
Plug:	TUV
Weight(g)	118.2
Dimensions (W) x (H) x (D) (mm)	125 x 205x 75
Inner Carton	
Packs / Inner ctn	8
Net Weight(kg)	0.95
Gross Weight(kg)	1.3
Dimensions (L)x (W) x (H) (cm)	49.5 x 23.5 x 14
Outer Carton	
Packs / Carton	32
Net Weight(kg)	3.78
Gross Weight(kg)	5.5
Dimensions (L)x (W) x (H) (cm)	50.5 x 48.5 x 30
Volume(M <sup>3</sup> )	0.0735

# Chargers ▶ Overnight Chargers

## BC-1001A

### Charges:

1-2 x AA

1-2 x AAA

1 x 9V

Ni-MH



### SPECIFICATIONS

Input: 100-240V ~ 50/60Hz

Output: 2 x (1.4V = 200 mA) AA/AAA Size

1 x (9V = 25 mA) 9V Size

### MAIN FEATURES

- 3 Independent Charging Channels
- 12 Hours Timer Control
- Reverse Polarity Protection
- Slim and Portable
- Built-in Switching Adaptor for Worldwide Use
- LED Indicators

Red	Charging
Off	Fully charged

### CHARGING TIMES

Type of Battery	Charging Times (Appr.)
Ni-MH AA 2700 mAh	12 h
Ni-MH AA 2000 mAh	12 h
Ni-MH AA 1500 mAh	10.5 h
Ni-MH AAA 800 mAh	5 h
Ni-MH 9V 200 mAh	9.5 h

### AVAILABLE COLORS

Titanium Black

### BARCODE



### PACKAGING



Blister		
Plug:	TUV	UL
Weight(g)	62	75.6
Dimensions (W) x (H) x (D) (mm)	87 x 172 x 50	87 x 172 x 50
Inner Carton		
Packs / Inner ctn	32	32
Net Weight(kg)	1.98	2.42
Gross Weight(kg)	2.42	3.07
Dimensions (L) x (W) x (H) (cm)	39.5 x 37.5 x 18	39.5 x 37.5 x 18
Outer Carton		
Packs / Carton	64	64
Net Weight(kg)	4.0	4.84
Gross Weight(kg)	7.5	6.54
Dimensions (L) x (W) x (H) (cm)	41 x 39 x 39	41 x 39 x 39
Volume(M <sup>3</sup> )	0.0624	0.0624



## BC-1009

### Charges:

1-2 × AA

1-2 × AAA



Ni-MH



\*Different plug models for different countries



## SPECIFICATIONS

Input: 100-240V~50/60Hz  
Output: 2 x (1.4V = 150mA)

## MAIN FEATURES

- 2 Independent Charging Channels
- Reverse Polarity Protection
- Comfortable Shell Case Design
- 2 LED Indicators

Red	Charging
Off	Fully Charged (BC1009A)

## CHARGING TIMES

Type of Battery	Charging Times (Appr.)
Ni-MH AA 2700 mAh	23 h
Ni-MH AA 2000 mAh	18 h
Ni-MH AA 1500 mAh	14 h
Ni-MH AAA 800 mAh	8 h
Ni-Cd AA 1000 mAh	9 h
Ni-Cd AAA 300 mAh	2.5 h

## AVAILABLE COLORS

White

## BARCODE

BC-1009-2H23



## PACKAGING



### Blister

Plug:	TUV	UL
Weight(g)	75	65
Dimensions(W)x(H)x(D)(mm)	90 x 172 x 72	90 x 172 x 50

### Inner Carton

Packs / Inner ctn	16	16
Net Weight(kg)	1.2	1.04
Gross Weight(kg)	1.6	1.35
Dimensions(L)x(W)x(H)(cm)	41.5 x 20 x 22.5	36 x 20 x 20

### Outer Carton

Packs / Carton	32	32
Net Weight(kg)	2.4	2.08
Gross Weight(kg)	3.5	3.2
Dimensions(L)x(W)x(H)(cm)	43 x 42 x 24.5	42 x 37.5 x 22
Volume(cbm)	0.0443	0.0347

# Chargers ▶ Overnight Chargers

## BC-0901

### Charges:

1-2 × AA  
1-2 × AAA

Ni-MH



### SPECIFICATIONS

Input: 100-240V ~ 50/60Hz 3W Max.  
Output: 2 x (1.4V = 150mA) AA/AAA size

### MAIN FEATURES

- 2 Independent Channels
- Reverse Polarity Protection

- LED Indicators

Red	Charging or charge complete
-----	-----------------------------

### CHARGING TIMES

Type of Battery	Charging Times (Appr.)
Ni-MH AA 2000 mAh	19 h
Ni-MH AA 1800 mAh	17 h
Ni-MH AAA 800 mAh	8 h

### AVAILABLE COLORS

 Silver

### BARCODE



### PACKAGING



Blister	
Plug:	TUV
Weight(g)	155
Dimensions (W) x (H) x (D) (mm)	125 x 205 x 80
Inner Carton	
Packs / Inner ctn	16
Net Weight(kg)	2.48
Gross Weight(kg)	2.73
Dimensions (L)x (W) x (H) (cm)	39.5 x 23.5 x 12.5
Outer Carton	
Packs / Carton	32
Net Weight(kg)	4.96
Gross Weight(kg)	7.2
Dimensions (L)x (W) x (H) (cm)	48.5 x 41 x 27
Volume(M <sup>3</sup> )	0.0537

## BC-0904S

### Charges:

2 or 4 × AA

2 or 4 × AAA

1-2 × 9V

Ni-MH



### SPECIFICATIONS

Input: 230V ~ 50Hz

Output: 2 x ( 2.8V  $\pm$  160 mA) AA size

2 x ( 2.8V  $\pm$  80 mA) AAA size

2 x ( 9V  $\pm$  25 mA) 9V size

### MAIN FEATURES

- 2 independent Charging Channels
- Low Charge Current for Longer Battery Life
- Reverse Polarity Protection
- LED Indicators

Red	Charging or charge complete
-----	-----------------------------

### CHARGING TIMES

Type of Battery	Charging Times (Appr.)
Ni-MH AA 2000 mAh	17 h
Ni-MH AA 1500 mAh	13 h
Ni-MH AAA 800 mAh	14 h
Ni-MH 9V 200 mAh	9.5 h

### AVAILABLE COLORS

 Silver

### BARCODE



### PACKAGING



Blister	
Plug:	TUV
Weight(g)	274
Dimensions (W) x (H) x (D) (mm)	210 x 130 x 84
Inner Carton	
Packs / Inner ctn	4
Net Weight(kg)	1.1
Gross Weight(kg)	1.3
Dimensions (L)x (W) x (H) (cm)	49.5 x 9 x 21.5
Outer Carton	
Packs / Carton	16
Net Weight(kg)	4.4
Gross Weight(kg)	7.5
Dimensions (L)x (W) x (H) (cm)	51 x 39 x 23.5
Volume(M <sup>3</sup> )	0.0467

# Chargers ▶ Universal Chargers

## CM9398GS

### Charges:

1- 4 AA / AAA / D / C or 1-2 9V  
Ni-MH Batteries



### SPECIFICATIONS

Input: 230V ~ 50Hz

Output: 4 x (1.4V  $\approx$  250mA) D/C/AA/AAA Size

2 x (9V  $\approx$  13mA) 9V Size

### MAIN FEATURES

- 4-channel for AAA, AA, C, D, and 2-channel for 9V batteries.
- The build-in battery change in tester.
- The timer can be selected, based on different capacity.
- Trickle charge function.
- Overcharge Protection Function.

### CHARGING TIMES

Type of Battery	Charging Times (Appr.)
Ni-MH D 2500 mAh	24 h
Ni-MH C 3500 mAh	24 h
Ni-MH AA 2500 mAh	24 h
Ni-MH AAA 900 mAh	6 h
Ni-MH 9V 200 mAh	20 h

### AVAILABLE COLORS

 Black

### BARCODE



### PACKAGING



Blister	
Weight(g)	680
Dimensions (W) x (H) x (D) (mm)	330 x 175 x 60
Inner Carton	
Packs / Inner ctn	10
Gross Weight(kg)	7.32
Dimensions (L)x (W) x (H) (cm)	59 x 23.5 x 19.5
Outer Carton	
Packs / Carton	20
Net Weight(kg)	13.7
Gross Weight(kg)	16.0
Dimensions (L)x (W) x (H) (cm)	62 x 36 x 46
Volume(M <sup>3</sup> )	0.10



## CM3298

### Charges:

1 - 4 C / D + 1 - 2 9V  
 1 - 6 AA / AAA + 1 - 2 9V  
 Ni-MH Batteries



### SPECIFICATIONS

Input: AC 100 ~ 240V 50Hz/60Hz 30W  
 Charging Current: 4 x C, D / DC 1.2V approx. 1.000mA  
                           6 x AAA / DC 1.2V approx. 500mA  
                           6 x AA / DC 1.2V approx. 1.000mA  
                           2 x DC 9V approx. 70mA  
 USB 5V: approx. 500mA max.

### MAIN FEATURES

- **8 Independent Charging Channels**
- **LCD Display** Shows the charging status of each individual Battery
- **6 Level Charge Protection**
  - Δ V Cut-Off
  - Timer Control Protection (10 hours)
  - Over Temperature Protection
  - Reverse Polarity Protection
  - Over Current and Short Circuit Protection
  - Defective and Non-rechargeable battery Detection
- **USB Port**  
Enables you to charge external devices such as MP3 players or mobile phones
- **Trickle Charge**
- **Discharge Function**  
9V battery can not be discharged
- **Battery Refresh Function**
- **World Voltage Switch Adapter**
- **LED Indicators**

Display	LED	Explanation
		The LED continuously glows green: <b>Full charged</b>
		The LED blinks alternately red and green: The batteries are being discharged for max. 10 minutes. <b>(Refresh Function)</b>
		The LED continuously glows red: <b>Charging:</b> The batteries are being charged
		<b>Loading error:</b> The LED blinks red: The inserted batteries are not positioned correctly in the charging slot or are defective.
		<b>Check / Precharge:</b> The LED blinks green: precharge / Check the batteries

### CHARGING TIMES

Type of Battery	Charging Times (Appr.)
Ni-MH AA 2500 mAh	3.5 h
Ni-MH AAA 900 mAh	2.5 h
Ni-MH C 4000 mAh	5.5 h
Ni-MH D 4500 mAh	6.2 h
Ni-MH 9V 200 mAh	4.0 h

### AVAILABLE COLORS

Silver

### BARCODE



### PACKAGING



Box	
Plug:	TUV
Weight(g)	660
Dimensions (W) x (H) x (D) (mm)	241.5 x 60 x 215
Outer Carton	
Packs / Carton	10
Net Weight(kg)	6.6
Gross Weight(kg)	7.3
Dimensions (L)x (W) x (H) (cm)	32 x 44.5 x 24
Volume(M³)	0.0341

# Chargers ▶ Universal Chargers

## CM9388

### Charges:

1- 4 AA / AAA / D / C or 1-2 9V  
Ni-MH Batteries



### SPECIFICATIONS

#### AC To DC Adapter

Input Voltage: AC 100 ~ 240V 50/60 Hz  
Output Voltage: 12V DC 1A

#### Charger

Charging Currents  
Input: DC 12V  
Output:  
4 x (1.4V = 300mA) D/C/AA/AAA Size  
2 x (9V = 13mA) 9V Size

### MAIN FEATURES

- 2 Independent Charging Channels
- To Charge AAA/AA/C/D/9V Ni-MH/Ni-Cd Rechargeable Battery
- V Detection Control
- Discharge Function
- Trickle Charge Function

### CHARGING TIMES

Type of Battery	Charging Times (Appr.)
Ni-MH D 2500 mAh	12 h
Ni-MH C 2500 mAh	12 h
Ni-MH AA 2500 mAh	12 h
Ni-MH AAA 900 mAh	3.5 h
Ni-MH 9V 200 mAh	22 h

### AVAILABLE COLORS

 Black

### BARCODE



### PACKAGING



Box	
Weight(g)	680
Dimensions (W) x (H) x (D) (mm)	275 x 155 x 88
Outer Carton	
Packs / Carton	20
Net Weight(kg)	24
Gross Weight(kg)	25.8
Dimensions (L)x (W) x (H) (cm)	56 x 47 x 35
Volume(M <sup>3</sup> )	0.0954

## LBC-313-1

### Charges:

Most 1.2V 3.7V or 7.4V Batteries\*

Li-ion

Ni-MH



### Includes:



Adapter + USB Cable



## SPECIFICATIONS

**Input:** DC 5V  $\pm$  1A

**Output:** 2 x (1.4V  $\pm$  0.7A) max (1.2V NH/NC Battery)  
4.2V  $\pm$  0.7A max (3.7V Li-ion Battery)  
8.4V  $\pm$  0.45A max (7.4V Li-ion Battery)

**Trickle Charging current:** 70mA

## MAIN FEATURES

- Charges Most 1.2V, 3.7V and 7.4V Li-ion/Ni-MH/Ni-Cd batteries
- Automatic Voltage and Polarity Selection Capability
- Automatic Detect Faulty and Defective Battery
- Timer Control Protection (5hrs for Ni-MH / Cd or 10hrs for Li-ion)
- USB Output Port Design

<b>Charging:</b>	Green LED flashes (1 time/s)
<b>Fully charged:</b>	Green LED remain on
<b>Errors:</b>	Red & Green LED flashes and stops charging after few seconds

## CHARGING TIMES

Battery Type	Battery Capacity	Charging Times(Appr.)
NP-30 3.7V Lithium-ion	1000 mAh	2.0h
CGR-320 7.4V Lithium-ion	3200 mAh	5.5h
14500 Lithium-ion	1000 mAh	2.0h
AA Ni-MH	1500 mAh	2.5h
AAA Ni-MH	800 mAh	1.5h
AA Ni-Cd	1000 mAh	2.0h
AAA Ni-Cd	300 mAh	30min

## AVAILABLE COLORS

 Black

## BARCODE



## PACKAGING



### Blister

<b>Plug:</b>	TUV
<b>Weight(g)</b>	154
<b>Dimensions(W)x(H)x(D)(mm)</b>	130x188.5x62

### Inner Carton

<b>Packs / Inner ctn</b>	16
<b>Net Weight(kg)</b>	1.35
<b>Gross Weight(kg)</b>	1.53
<b>Dimensions(L)x(W)x(H)(cm)</b>	33x25.5x14.2

### Outer Carton

<b>Packs / Carton</b>	32
<b>Net Weight(kg)</b>	6.1
<b>Gross Weight(kg)</b>	7.6
<b>Dimensions(L)x(W)x(H)(cm)</b>	52.5x34.5x30.5
<b>Volume(cbm)</b>	0.0553

# Chargers ▶ Universal Chargers

## LBC-321

Charges:  
 1-4 x  
 1.2V  
 3.2V  
 3.7V  
 3.85V

**Ni-MH**  
**Ni-Cd**  
**Li-Fe**  
**Li-ion**



### SPECIFICATIONS

**Input:** Micro USB 5V  $\overline{=}$  2A

**Output:**

**Charging Voltage:**

1.42V 4.2V $\pm$ 0.05V, 3.65 $\pm$ 0.05V  
 4.35 $\pm$ 0.05V

**Charging Current:**

1 PCS(4th Slot Only):

2000mA/1000mA/700mA/500mA

2 PCS: 1000mA/700mA/500mA

3 PCS: 700mA/500mA

4 PCS: 500mA

USB Output Function

USB Output (Request battery at the 4th Slot) 5V  $\overline{=}$  1A

### MAIN FEATURES

- **Smart Charging** detects the battery status and activates deep discharged batteries, as well the multiple charging protections functions effectively prevent overcharge and undercharge, ensure charging safety and improve the cycle life of the battery
- **Four Charging Current** adapt to different charging current according to the battery type
- **Four Independent Charging Channels** separately charge 1 - 4 batteries
- **LED Indicator** indicate each batteries' charging status
- **Smart Detection** automatically identifies Li-ion and Ni-MH batteries
- **USB Output** can perform as a charging device, charging other devices when placing one suitable battery at the right column
- **Over-charging, Over-discharging, short circuit and reverse polarity protection**

#### LED Indicators

Blue LED flashing	Charging
Blue LED constant on	Fully charged

### CHARGING TIMES

Battery Type	Battery Capacity	Charging Times (Appr.)
26650Li-ion	5000mAh	12 hours
18650Li-ion	2500mAh	6.0 hours
18650Li-ion	2000mAh	5.0 hours
18500Li-ion	1500mAh	3.5 hours
17335Li-ion	700mAh	100 min
Ni-MHAA	2000mAh	5.0 hours
Ni-MHAAA	1000mAh	2.5 hours

### AVAILABLE COLORS

Black

### BARCODE



### PACKAGING



Box	
Plug:	TUV
Weight(g)	155
Dimensions (W) x (H) x (D) (mm)	130 x 205 x 51
Inner Carton	
Packs / Inner ctn	12
Net Weight(kg)	/
Gross Weight(kg)	/
Dimensions (L)x (W) x (H) (cm)	31.5 x 27.8 x 14.5
Outer Carton	
Packs / Carton	48
Net Weight(kg)	7.5
Gross Weight(kg)	8.6
Dimensions (L)x (W) x (H) (cm)	57 x 33 x 31
Volume(M <sup>3</sup> )	0.0583



## ► Li-ion Charger

### LBC-305

Charges:

1-2 × **18650** | **Li-ion**



USB Charger



### SPECIFICATIONS

Input: Micro USB 5V  $\pm$  1A

Output: 3.7V  $\pm$  500mA

Caution: Specialized charger for  
18650 Lithium-ion batteries

### MAIN FEATURES

- Two independent charging channels
- Suitable for flat-top and high top 18650 Li-ion batteries
- Reverse polarity protection
- Over-charge protection
- Short circuit protection
- Power indicator

Red LED	Charging
Green LED	Fully charged

### CHARGING TIMES

Battery Type	Battery Capacity	Charging Times(Appr.)
18650 Lithium-ion	2600 mAh	6.5 hours
18650 Lithium-ion	2200 mAh	5.5 hours
18650 Lithium-ion	1800 mAh	4.5 hours
18650 Lithium-ion	1500 mAh	4.0 hours

### AVAILABLE COLORS

 Black

### BARCODE

LBC-305-DB



4 260216 456763

### PACKAGING



Blister	
Plug:	\
Weight(g)	108
Dimensions(W)x(H)x(D)(mm)	95 x 176 x 64
Inner Carton	
Packs / Inner ctn	10
Net Weight(kg)	1.075
Gross Weight(kg)	1.425
Dimensions(L)x(W)x(H)(cm)	48.5 x 19 x 10.5
Outer Carton	
Packs / Carton	40
Net Weight(kg)	4.3
Gross Weight(kg)	5.8
Dimensions(L)x(W)x(H)(cm)	50.5 x 40 x 23.5
Volume(cbm)	0.0474

# Battery Charging Table

## Directions:

The following table lists out charging times for specific Camelion chargers and batteries.

For example, to find the charging time for the BC-0907 charger using a Nickel Metal Hydride AA2500mah battery, first locate the BC-0907 column. Then locate the AA2500mah row. Finally, the point of intersection indicates the value, which is 80min.

Camelion Model	BC-0907	BC-0905A		BC-1012			BC-1010B	BC-0901	BC-1002F	BC-1001A
	DC in 12V, 1.5A	2 cells	4 cells	1-2 cells	3 cells	4 cells				
Timer Control	1.5h	3.5h	7.0h	6.0h	9.0h	12h	NA	NA	NA	Voltage Cut Off
<b>Ni-MH Batteries</b>										
NH-D2500	NA	NA	NA	NA	NA	NA	NA	NA	NA	NA
NH-C2500	NA	NA	NA	NA	NA	NA	NA	NA	NA	NA
NH-AA2700	80min	3h	6h	T/C 6h	T/C 9h	T/C 12h	17h	23.0h	8h	T/C 12h
NH-AA2600	80min	3h	5.5h	T/C 6h	T/C 9h	T/C 12h	16h	22.0h	7h	T/C 12h
NH-AA2500	80min	3h	5.5h	T/C 6h	T/C 9h	T/C 12h	16h	22.0h	6h	T/C 12h
NH-AA2300	70min	3h	5.5h	T/C 6h	T/C 9h	T/C 12h	16h	21.0h	5.5h	T/C 12h
NH-AA2200	70min	2.5h	5h	T/C 6h	T/C 9h	T/C 12h	15h	20.0h	5.5h	T/C 12h
NH-AA2000	60min	2.5h	4.5h	T/C 6h	T/C 9h	T/C 12h	14h	19.0h	5h	T/C 12h
NH-AA1800	60min	2h	4.5h	6h	T/C 9h	T/C 12h	13h	17.0h	4.5h	T/C 12h
NH-AA1500	50min	2h	3.5h	4.5h	7h	10.5h	11h	14.0h	3.5h	10.5h
NH-AAA1100	90min	2h	4h	T/C 6h	T/C 9h	T/C 12h	6h	9.0h	5.5h	6h
NH-AAA1000	80min	2h	3.5h	T/C 6h	T/C 9h	T/C 12h	5.5h	9.0h	5h	5.5h
NH-AAA900	80min	100min	3.5h	5h	T/C 9h	12h	5h	8.0h	4.5h	5h
NH-AAA800	70min	100min	3h	5h	8.5h	11h	5h	8.0h	4h	5h
NH-AAA600	60min	70min	2.5h	3.5h	5.5h	7h	3.5h	5.0h	3h	3.5h
NH-9V250	NA	NA	NA	NA	NA	NA	22h	NA	NA	11h
NH-9V200	NA	NA	NA	NA	NA	NA	18h	NA	NA	9.5h

Camelion Model	BC-0904S	BC-1009	CM-9398GS	CM3298	CM9388	LBC-321				LBC-313-1
						500mA	700mA	1000mA	2000mA	
Timer Control	NA	NA	3 / 6 / 9 / 24h	10h	NA	NA				NA
<b>Ni-MH Batteries</b>										
NH-D2500	NA	NA	14h	3h	12h	NA				NA
NH-C2500	NA	NA	14h	3h	12h	7h	5h	3.5h	90min	NA
NH-AA2700	22h	23h	14h	3h	12h	7h	5h	3.5h	90min	4.5h
NH-AA2600	20h	22h	13h	3h	12h	7h	5h	3.5h	90min	4h
NH-AA2500	20h	22h	13h	3h	12h	7h	5h	3.5h	90min	4h
NH-AA2300	19h	21h	12h	2.5h	10h	6h	4.5h	3h	85min	4h
NH-AA2200	19h	20h	12h	2.5h	10h	6h	4.5h	3h	80min	3.5h
NH-AA2000	17h	18h	10.5h	2.5h	9.5h	5.5h	4h	2.5h	70min	3.5h
NH-AA1800	16h	17h	10h	2h	8.5h	5h	4h	2.5h	65min	3h
NH-AA1500	13h	14h	8.5h	2h	7h	4h	3h	2h	55min	2.5h
NH-AAA1100	17h	9h	4.5h	2.5h	4h	2.5h	100min	70min	35min	100min
NH-AAA1000	16h	9h	4.5h	2h	3.5h	2.5h	100min	70min	35min	100min
NH-AAA900	15h	8h	3.5h	2h	3.5h	2h	90min	65min	35min	90min
NH-AAA800	14h	8h	3.5h	2h	3h	2h	90min	60min	30min	90min
NH-AAA600	10.5h	5h	3h	1.5h	2.5h	90min	60min	45min	20min	1h
NH-9V250	11h	NA	11h	4.5h	27h	NA				NA
NH-9V200	9.5h	NA	9.5h	3.5h	22h	NA				NA

### Notes:

NA - Not Applicable.

T/C: Charger has timer control. This is the cut off time, whether the battery is fully charged or not.

All the data is based on Camelion latest lab tests. Charging times may vary based upon temperature, product age, voltage and other conditions. This data sheet is for customer reference purposes only and to help customers choose the appropriate product. Contents do not constitute a warranty.

For information on specific Camelion products please visit our website at [www.camelionbattery.com](http://www.camelionbattery.com) or contact us directly at [info@camelionbattery.com](mailto:info@camelionbattery.com).

# Rechargeable ▶ AlwaysReady Batteries

## AlwaysReady™ Ni-MH Always Ready Rechargeable Batteries

The new Camelion AlwaysReady battery is ready to be used right from the package. **It holds the charge for up to a year.** And they can be recharged again and again, saving you money. Are you ready? Try AlwaysReady batteries today!



### NH-AA2500ARBP2

<b>1.2V AA</b>	4 260216 453038
<b>Packaging</b>	
<b>Blister</b>	2 pcs/pack
<b>Inner Box</b>	12 packs/box
<b>Outer Carton</b>	192 packs/carton
<b>Gross Weight:</b>	13.1 kg
<b>Volume:</b>	0.0274 cbm

<b>Dimensions</b>	
<b>Blister (mm)</b>	90(W) x 117(H) x 15(D)
<b>Inner Box (mm)</b>	134(L) x 104(W) x 97(H)
<b>Outer Carton (cm)</b>	41.0(L) x 29.0(W) x 23.0(H)



### NH-9V200ARBP1

<b>9V</b>	4 260033 1155221
<b>Packaging</b>	
<b>Blister</b>	1 pcs/pack
<b>Inner Box</b>	12 packs/box
<b>Outer Carton</b>	240 packs/carton
<b>Gross Weight:</b>	12.0 kg
<b>Volume:</b>	0.0385 cbm

<b>Dimensions</b>	
<b>Blister (mm)</b>	90(W) x 117(H) x 18(D)
<b>Inner Box (mm)</b>	135(L) x 125(W) x 97(H)
<b>Outer Carton (cm)</b>	51.0(L) x 29.0(W) x 26.0(H)



### NH-AA2300ARBP4

<b>1.2V AA</b>	4 260033 1154040
<b>Packaging</b>	
<b>Blister</b>	4 pcs/pack
<b>Inner Box</b>	12 packs/box
<b>Outer Carton</b>	96 packs/carton
<b>Gross Weight:</b>	11.8 kg
<b>Volume:</b>	0.0144 cbm

<b>Dimensions</b>	
<b>Blister (mm)</b>	90(W) x 117(H) x 15(D)
<b>Inner Box (mm)</b>	134(L) x 104(W) x 97(H)
<b>Outer Carton (cm)</b>	29.0(L) x 21.5(W) x 23.0(H)



### NH-AA2300ARBP2

<b>1.2V AA</b>	4 260033 1152336
<b>Packaging</b>	
<b>Blister</b>	2 pcs/pack
<b>Inner Box</b>	12 packs/box
<b>Outer Carton</b>	192 packs/carton
<b>Gross Weight:</b>	12.9 kg
<b>Volume:</b>	0.0274 cbm

<b>Dimensions</b>	
<b>Blister (mm)</b>	90(W) x 117(H) x 15(D)
<b>Inner Box (mm)</b>	134(L) x 104(W) x 97(H)
<b>Outer Carton (cm)</b>	41.0(L) x 29.0(W) x 23.0(H)



### NH-AAA800ARBP4

<b>1.2V AAA</b>	4 260033 1152312
<b>Packaging</b>	
<b>Blister</b>	4 pcs/pack
<b>Inner Box</b>	12 packs/box
<b>Outer Carton</b>	144 packs/carton
<b>Gross Weight:</b>	9.2 kg
<b>Volume:</b>	0.0168 cbm

<b>Dimensions</b>	
<b>Blister (mm)</b>	90(W) x 117(H) x 11(D)
<b>Inner Box (mm)</b>	125(L) x 84(W) x 97(H)
<b>Outer Carton (cm)</b>	31.0(L) x 27.0(W) x 20.0(H)



### NH-AAA800ARBP2

<b>1.2V AAA</b>	4 260033 1152305
<b>Packaging</b>	
<b>Blister</b>	2 pcs/pack
<b>Inner Box</b>	12 packs/box
<b>Outer Carton</b>	240 packs/carton
<b>Gross Weight:</b>	8.4 kg
<b>Volume:</b>	0.0269 cbm

<b>Dimensions</b>	
<b>Blister (mm)</b>	90(W) x 117(H) x 11(D)
<b>Inner Box (mm)</b>	125(L) x 84(W) x 97(H)
<b>Outer Carton (cm)</b>	51.0(L) x 27.0(W) x 19.5(H)

## Energy solutions for Solar powered devices

Camelion Ni-MH rechargeable batteries are perfect solutions for outdoor solar powered equipment. The battery offers a longer life cycle and is outstanding in sustaining its energy when charged by solar powered devices. It is the ideal choice for outdoor equipments such as trail lights.



### NH-AA800ARBP4

<b>1.2V AA</b>		
	4 260216 453229	
<b>Packaging</b>		
<b>Blister</b>	4 pcs/pack	<b>Gross Weight:</b> 12.4 kg
<b>Inner Box</b>	12 packs/box	<b>Volume:</b> 0.0144 cbm
<b>Outer Carton</b>	96 packs/carton	
<b>Dimensions</b>		
<b>Blister (mm)</b>	90(W) x 117(H) x 15(D)	
<b>Inner Box (mm)</b>	134(L) x 104(W) x 97(H)	
<b>Outer Carton (cm)</b>	29.0(L) x 21.5(W) x 23.0(H)	



### NH-AA800ARBP2

<b>1.2V AA</b>		
	4 260216 453236	
<b>Packaging</b>		
<b>Blister</b>	2 pcs/pack	<b>Gross Weight:</b> 12.4 kg
<b>Inner Box</b>	12 packs/box	<b>Volume:</b> 0.0274 cbm
<b>Outer Carton</b>	192 packs/carton	
<b>Dimensions</b>		
<b>Blister (mm)</b>	90(W) x 117(H) x 15(D)	
<b>Inner Box (mm)</b>	134(L) x 104(W) x 97(H)	
<b>Outer Carton (cm)</b>	41.0(L) x 29.0(W) x 23.0(H)	



### NH-AA600ARBP4(GSL)

<b>1.2V AA</b>		
	4 260216 4455667	
<b>Packaging</b>		
<b>Blister</b>	4 pcs/pack	<b>Gross Weight:</b> 11.4 kg
<b>Inner Box</b>	12 packs/box	<b>Volume:</b> 0.0144 cbm
<b>Outer Carton</b>	96 packs/carton	
<b>Dimensions</b>		
<b>Blister (mm)</b>	90(W) x 117(H) x 15(D)	
<b>Inner Box (mm)</b>	134(L) x 104(W) x 97(H)	
<b>Outer Carton (cm)</b>	29.0(L) x 21.5(W) x 23.0(H)	



### NH-AA600ARBP2(GSL)

<b>1.2V AA</b>		
	4 260216 4457210	
<b>Packaging</b>		
<b>Blister</b>	2 pcs/pack	<b>Gross Weight:</b> 11.4 kg
<b>Inner Box</b>	12 packs/box	<b>Volume:</b> 0.0274 cbm
<b>Outer Carton</b>	192 packs/carton	
<b>Dimensions</b>		
<b>Blister (mm)</b>	90(W) x 117(H) x 15(D)	
<b>Inner Box (mm)</b>	134(L) x 104(W) x 97(H)	
<b>Outer Carton (cm)</b>	41.0(L) x 29.0(W) x 23.0(H)	



### NH-AAA600ARBP4(GSL)

<b>1.2V AAA</b>		
	4 260216 4455674	
<b>Packaging</b>		
<b>Blister</b>	4 pcs/pack	<b>Gross Weight:</b> 8.6 kg
<b>Inner Box</b>	12 packs/box	<b>Volume:</b> 0.0168 cbm
<b>Outer Carton</b>	144 packs/carton	
<b>Dimensions</b>		
<b>Blister (mm)</b>	90(W) x 117(H) x 11(D)	
<b>Inner Box (mm)</b>	125(L) x 84(W) x 97(H)	
<b>Outer Carton (cm)</b>	31.0(L) x 27.0(W) x 20.0(H)	



### NH-AAA600ARBP2(GSL)

<b>1.2V AAA</b>		
	4 260216 4453250	
<b>Packaging</b>		
<b>Blister</b>	2 pcs/pack	<b>Gross Weight:</b> 8.4 kg
<b>Inner Box</b>	12 packs/box	<b>Volume:</b> 0.0268 cbm
<b>Outer Carton</b>	240 packs/carton	
<b>Dimensions</b>		
<b>Blister (mm)</b>	90(W) x 117(H) x 11(D)	
<b>Inner Box (mm)</b>	125(L) x 84(W) x 97(H)	
<b>Outer Carton (cm)</b>	51.0(L) x 27.0(W) x 19.5(H)	



### FA-16H6/12H8ARBP4D28

<b>1.2V AA/AAA</b>		
	4 260216 4457227	
<b>Packaging</b>		
<b>Blister</b>	4 pcs/pack	<b>Gross Weight:</b> 8.45 kg
<b>Inner Box</b>	28 packs/box	<b>Volume:</b> 0.0280 cbm
<b>Outer Carton</b>	112 packs/carton	
<b>Dimensions</b>		
<b>Blister (mm)</b>	90(W) x 117(H) x 15(D)	
<b>Inner Box (mm)</b>	190(L) x 202(W) x 125(H)	
<b>Outer Carton (cm)</b>	44.5(L) x 42.0(W) x 15.0(H)	



# Rechargeable ▶ Ni-MH Batteries



Camelion Ni-MH Rechargeable batteries offer high capacity performance, up to 1000 recharge cycles, and because they are used again and again they help reduce environmental waste. High drain devices such as music players and digital cameras are supported, therefore, you can hear more songs and take more photos.



**NH-D7000BP2**

**1.2V D**

4 260033 151520

<b>Packaging</b>	2 pcs/pack	<b>Gross Weight:</b>	19.0 kg
<b>Blister</b>	6 packs/box	<b>Volume:</b>	0.0234 cbm
<b>Inner Box</b>	60 packs/carton		
<b>Outer Carton</b>			

**Dimensions**

<b>Blister (mm)</b>	90(W) x 117(H) x 34(D)
<b>Inner Box (mm)</b>	160(L) x 112(W) x 97(H)
<b>Outer Carton (cm)</b>	34.0(L) x 27.5(W) x 25.0(H)



**NH-D10000BP2**

**1.2V D**

4 260033 151865

<b>Packaging</b>	2 pcs/pack	<b>Gross Weight:</b>	17.0 kg
<b>Blister</b>	6 packs/box	<b>Volume:</b>	0.0244 cbm
<b>Inner Box</b>	48 packs/carton		
<b>Outer Carton</b>			

**Dimensions**

<b>Blister (mm)</b>	90(W) x 117(H) x 34(D)
<b>Inner Box (mm)</b>	165(L) x 135(W) x 105(H)
<b>Outer Carton (cm)</b>	43.5(L) x 35.0(W) x 16.0(H)



**NH-C3500BP2**

**1.2V C**

4 260033 151544

<b>Packaging</b>	2 pcs/pack	<b>Gross Weight:</b>	16.8 kg
<b>Blister</b>	6 packs/box	<b>Volume:</b>	0.0248 cbm
<b>Inner Box</b>	96 packs/carton		
<b>Outer Carton</b>			

**Dimensions**

<b>Blister (mm)</b>	90(W) x 117(H) x 27(D)
<b>Inner Box (mm)</b>	138(L) x 90(W) x 97(H)
<b>Outer Carton (cm)</b>	41.0(L) x 29.5(W) x 20.5(H)



**NH-D2500BP2**

**1.2V D**

4 260033 151537

<b>Packaging</b>	2 pcs/pack	<b>Gross Weight:</b>	11.2 kg
<b>Blister</b>	6 packs/box	<b>Volume:</b>	0.0234 cbm
<b>Inner Box</b>	60 packs/carton		
<b>Outer Carton</b>			

**Dimensions**

<b>Blister (mm)</b>	90(W) x 117(H) x 34(D)
<b>Inner Box (mm)</b>	160(L) x 112(W) x 97(H)
<b>Outer Carton (cm)</b>	34.0(L) x 27.5(W) x 25.0(H)



**NH-C2500BP2**

**1.2V C**

4 260033 151551

<b>Packaging</b>	2 pcs/pack	<b>Gross Weight:</b>	16.0 kg
<b>Blister</b>	6 packs/box	<b>Volume:</b>	0.0248 cbm
<b>Inner Box</b>	96 packs/carton		
<b>Outer Carton</b>			

**Dimensions**

<b>Blister (mm)</b>	90(W) x 117(H) x 27(D)
<b>Inner Box (mm)</b>	138(L) x 90(W) x 97(H)
<b>Outer Carton (cm)</b>	41.0(L) x 29.5(W) x 20.5(H)



**NH-AA2700BC4**

**1.2V AA**

4 260033 151933

<b>Packaging</b>	4 pcs/pack	<b>Gross Weight:</b>	13.4 kg
<b>Blister</b>	12 packs/box	<b>Volume:</b>	0.0144 cbm
<b>Inner Box</b>	96 packs/carton		
<b>Outer Carton</b>			

**Dimensions**

<b>Blister (mm)</b>	90(W) x 117(H) x 15(D)
<b>Inner Box (mm)</b>	134(L) x 104(W) x 97(H)
<b>Outer Carton (cm)</b>	29.0(L) x 21.5(W) x 23.0(H)



**NH-AA2700BC2**

**1.2V AA**

4 260033 151926

<b>Packaging</b>	2 pcs/pack	<b>Gross Weight:</b>	14.0 kg
<b>Blister</b>	12 packs/box	<b>Volume:</b>	0.0274 cbm
<b>Inner Box</b>	192 packs/carton		
<b>Outer Carton</b>			

**Dimensions**

<b>Blister (mm)</b>	90(W) x 117(H) x 15(D)
<b>Inner Box (mm)</b>	134(L) x 104(W) x 97(H)
<b>Outer Carton (cm)</b>	41.0(L) x 29.0(W) x 23.0(H)



## NH-AA2500BC4

1.2V AA



4 260033 151834

<b>Packaging</b>	4 pcs/pack	<b>Gross Weight:</b>	13.0 kg
<b>Blister</b>	12 packs/box	<b>Volume:</b>	0.0144 cbm
<b>Inner Box</b>	96 packs/carton		
<b>Outer Carton</b>			

### Dimensions

<b>Blister (mm)</b>	90(W) x 117(H) x 15(D)
<b>Inner Box (mm)</b>	134(L) x 104(W) x 97(H)
<b>Outer Carton (cm)</b>	29.0(L) x 21.5(W) x 23.0(H)



## NH-AA2500BC2

1.2V AA



4 260033 151827

<b>Packaging</b>	2 pcs/pack	<b>Gross Weight:</b>	14.3 kg
<b>Blister</b>	12 packs/box	<b>Volume:</b>	0.0274 cbm
<b>Inner Box</b>	192 packs/carton		
<b>Outer Carton</b>			

### Dimensions

<b>Blister (mm)</b>	90(W) x 117(H) x 15(D)
<b>Inner Box (mm)</b>	134(L) x 104(W) x 97(H)
<b>Outer Carton (cm)</b>	41.0(L) x 29.0(W) x 23.0(H)



## NH-AA2300BP4

1.2V AA



4 260033 151742

<b>Packaging</b>	4 pcs/pack	<b>Gross Weight:</b>	12.6 kg
<b>Blister</b>	12 packs/box	<b>Volume:</b>	0.0144 cbm
<b>Inner Box</b>	96 packs/carton		
<b>Outer Carton</b>			

### Dimensions

<b>Blister (mm)</b>	90(W) x 117(H) x 15(D)
<b>Inner Box (mm)</b>	134(L) x 104(W) x 97(H)
<b>Outer Carton (cm)</b>	29.0(L) x 21.5(W) x 23.0(H)



## NH-AA2300BP2

1.2V AA



4 260033 151735

<b>Packaging</b>	2 pcs/pack	<b>Gross Weight:</b>	13.9 kg
<b>Blister</b>	12 packs/box	<b>Volume:</b>	0.0274 cbm
<b>Inner Box</b>	192 packs/carton		
<b>Outer Carton</b>			

### Dimensions

<b>Blister (mm)</b>	90(W) x 117(H) x 15(D)
<b>Inner Box (mm)</b>	134(L) x 104(W) x 97(H)
<b>Outer Carton (cm)</b>	41.0(L) x 29.0(W) x 23.0(H)



## NH-AA2000BP2

1.2V AA



4 260033 151582

<b>Packaging</b>	2 pcs/pack	<b>Gross Weight:</b>	13.1 kg
<b>Blister</b>	12 packs/box	<b>Volume:</b>	0.0274 cbm
<b>Inner Box</b>	192 packs/carton		
<b>Outer Carton</b>			

### Dimensions

<b>Blister (mm)</b>	90(W) x 117(H) x 15(D)
<b>Inner Box (mm)</b>	134(L) x 104(W) x 97(H)
<b>Outer Carton (cm)</b>	41.0(L) x 29.0(W) x 23.0(H)



## NH-AA1800BP4

1.2V AA



4 260033 151612

<b>Packaging</b>	4 pcs/pack	<b>Gross Weight:</b>	11.8 kg
<b>Blister</b>	12 packs/box	<b>Volume:</b>	0.0144 cbm
<b>Inner Box</b>	96 packs/carton		
<b>Outer Carton</b>			

### Dimensions

<b>Blister (mm)</b>	90(W) x 117(H) x 15(D)
<b>Inner Box (mm)</b>	134(L) x 104(W) x 97(H)
<b>Outer Carton (cm)</b>	29.0(L) x 21.5(W) x 23.0(H)



## NH-AA1800BP2

1.2V AA



4 260033 151605

<b>Packaging</b>	2 pcs/pack	<b>Gross Weight:</b>	12.7 kg
<b>Blister</b>	12 packs/box	<b>Volume:</b>	0.0274 cbm
<b>Inner Box</b>	192 packs/carton		
<b>Outer Carton</b>			

### Dimensions

<b>Blister (mm)</b>	90(W) x 117(H) x 15(D)
<b>Inner Box (mm)</b>	134(L) x 104(W) x 97(H)
<b>Outer Carton (cm)</b>	41.0(L) x 29.0(W) x 23.0(H)



## NH-AA1500BP2

1.2V AA



4 260033 151629

<b>Packaging</b>	2 pcs/pack	<b>Gross Weight:</b>	11.2 kg
<b>Blister</b>	12 packs/box	<b>Volume:</b>	0.0274 cbm
<b>Inner Box</b>	192 packs/carton		
<b>Outer Carton</b>			

### Dimensions

<b>Blister (mm)</b>	90(W) x 117(H) x 15(D)
<b>Inner Box (mm)</b>	134(L) x 104(W) x 97(H)
<b>Outer Carton (cm)</b>	41.0(L) x 29.0(W) x 23.0(H)

# Rechargeable ▶ Ni-MH Batteries



## NH-AAA1100BP4

**1.2V AAA**



Packaging 4 260033 151957  
 Blister 4 pcs/pack  
 Inner Box 12 packs/box  
 Outer Carton 144 packs/carton  
 Gross Weight: 9.8 kg  
 Volume: 0.0168 cbm

### Dimensions

Blister (mm) 90(W) x 117(H) x 11(D)  
 Inner Box (mm) 125(L) x 84(W) x 97(H)  
 Outer Carton (cm) 31.0(L) x 27.0(W) x 20.0(H)



## NH-AAA1100BP2

**1.2V AAA**



Packaging 4 260033 151940  
 Blister 2 pcs/pack  
 Inner Box 12 packs/box  
 Outer Carton 240 packs/carton  
 Gross Weight: 9.7 kg  
 Volume: 0.0269 cbm

### Dimensions

Blister (mm) 90(W) x 117(H) x 11(D)  
 Inner Box (mm) 125(L) x 84(W) x 97(H)  
 Outer Carton (cm) 51.0(L) x 27.0(W) x 19.5(H)



## NH-AAA1000BP4

**1.2V AAA**



Packaging 4 260033 151889  
 Blister 4 pcs/pack  
 Inner Box 12 packs/box  
 Outer Carton 144 packs/carton  
 Gross Weight: 8.7 kg  
 Volume: 0.0168 cbm

### Dimensions

Blister (mm) 90(W) x 117(H) x 11(D)  
 Inner Box (mm) 125(L) x 84(W) x 97(H)  
 Outer Carton (cm) 31.0(L) x 27.0(W) x 20.0(H)



## NH-AAA1000BP2

**1.2V AAA**



Packaging 4 260033 151872  
 Blister 2 pcs/pack  
 Inner Box 12 packs/box  
 Outer Carton 240 packs/carton  
 Gross Weight: 8.7 kg  
 Volume: 0.0269 cbm

### Dimensions

Blister (mm) 90(W) x 117(H) x 11(D)  
 Inner Box (mm) 125(L) x 84(W) x 97(H)  
 Outer Carton (cm) 51.0(L) x 27.0(W) x 19.5(H)



## NH-AAA900BP4

**1.2V AAA**



Packaging 4 260033 151766  
 Blister 4 pcs/pack  
 Inner Box 12 packs/box  
 Outer Carton 144 packs/carton  
 Gross Weight: 8.7 kg  
 Volume: 0.0168 cbm

### Dimensions

Blister (mm) 90(W) x 117(H) x 11(D)  
 Inner Box (mm) 125(L) x 84(W) x 97(H)  
 Outer Carton (cm) 31.0(L) x 27.0(W) x 20.0(H)



## NH-AAA900BP2

**1.2V AAA**



Packaging 4 260033 151759  
 Blister 2 pcs/pack  
 Inner Box 12 packs/box  
 Outer Carton 240 packs/carton  
 Gross Weight: 8.7 kg  
 Volume: 0.0269 cbm

### Dimensions

Blister (mm) 90(W) x 117(H) x 11(D)  
 Inner Box (mm) 125(L) x 84(W) x 97(H)  
 Outer Carton (cm) 51.0(L) x 27.0(W) x 19.5(H)



## NH-AAA800BP2

**1.2V AAA**



Packaging 4 260033 151667  
 Blister 2 pcs/pack  
 Inner Box 12 packs/box  
 Outer Carton 240 packs/carton  
 Gross Weight: 7.7 kg  
 Volume: 0.0269 cbm

### Dimensions

Blister (mm) 90(W) x 117(H) x 11(D)  
 Inner Box (mm) 125(L) x 84(W) x 97(H)  
 Outer Carton (cm) 51.0(L) x 27.0(W) x 19.5(H)





**NH-AAA600BP4**

**1.2V AAA**



**Packaging**  
**Blister** 4 pcs/pack  
**Inner Box** 12 packs/box  
**Outer Carton** 144 packs/carton

**Gross Weight:** 7.8 kg  
**Volume:** 0.0168 cbm

**Dimensions**

**Blister (mm)** 90(W) x 117(H) x 11(D)  
**Inner Box (mm)** 125(L) x 84(W) x 97(H)  
**Outer Carton (cm)** 31.0(L) x 27.0(W) x 20.0(H)



**NH-AAA600BP2**

**1.2V AAA**



**Packaging**  
**Blister** 2 pcs/pack  
**Inner Box** 12 packs/box  
**Outer Carton** 240 packs/carton

**Gross Weight:** 7.7 kg  
**Volume:** 0.0269 cbm

**Dimensions**

**Blister (mm)** 90(W) x 117(H) x 11(D)  
**Inner Box (mm)** 125(L) x 84(W) x 97(H)  
**Outer Carton (cm)** 51.0(L) x 27.0(W) x 19.5(H)



**NH-9V250BP1**

**9V Voltage: 8.4V**



**Packaging**  
**Blister** 1 pcs/pack  
**Inner Box** 12 packs/box  
**Outer Carton** 240 packs/carton

**Gross Weight:** 12.3 kg  
**Volume:** 0.0385 cbm

**Dimensions**

**Blister (mm)** 90(W) x 117(H) x 18(D)  
**Inner Box (mm)** 135(L) x 125(W) x 97(H)  
**Outer Carton (cm)** 51.0(L) x 29.0(W) x 26.0(H)



**NH-9V200BP1**

**9V Voltage: 8.4V**



**Packaging**  
**Blister** 1 pcs/pack  
**Inner Box** 12 packs/box  
**Outer Carton** 240 packs/carton

**Gross Weight:** 11.6 kg  
**Volume:** 0.0385 cbm

**Dimensions**

**Blister (mm)** 90(W) x 117(H) x 18(D)  
**Inner Box (mm)** 135(L) x 125(W) x 97(H)  
**Outer Carton (cm)** 51.0(L) x 29.0(W) x 26.0(H)



**Lithium-ion Rechargeable Batteries**

- Uses up to 500 charge-discharge cycles
- Wide operating temperature range
- Holds 85% charge over 6 months



**ICR18650F-26 bulk**

**3.7V 2600**



**Packaging**  
**Inner Box** 24 packs/box  
**Outer Carton** 216 packs/carton

**Gross Weight:** 12.05 kg  
**Volume:** 0.0128 cbm

**Dimensions**

**Inner Box (mm)** 120(L) x 80(W) x 70(H)  
**Outer Carton (cm)** 32(L) x 15(W) x 26(H)



**ICR18650F-22 bulk**

**3.7V 2200**



**Packaging**  
**Inner Box** 24 packs/box  
**Outer Carton** 216 packs/carton

**Gross Weight:** 11.9 kg  
**Volume:** 0.0128 cbm

**Dimensions**

**Inner Box (mm)** 120(L) x 80(W) x 70(H)  
**Outer Carton (cm)** 32(L) x 15(W) x 26(H)

# Power Supplies

---





Camelion Power Banks offers you fast, easy and reliable power source for your mobile devices. Integrated with top quality battery cells, we ensure you a product of long life and fully compliant with international safety standards



## Power Supplies ▶ Powerbanks

### PS675



PS675-DB



Accessory:  
USB Cable  
(L:30cm)



LED Status (● ON ○ OFF)	Capacity
● ● ● ●	76%-100%
○ ● ● ●	51%-75%
○ ○ ● ●	26%-50%
○ ○ ○ ●	<25%

#### Main Features

- LED flashlight function
- 2.1A output
- Compatible with most mobile devices
- Short circuit, over discharge, overcharge and over current protections
- Specially designed cover – unique and elegant

#### Specifications

**Battery Capacity:** 6000mAh Li-polymer battery 22.2Wh

**Power Input:** Micro USB 5V  $\pm$  2A

**Power Output:** 5V  $\pm$  2.1A

#### Packaging

Blister	Weight(g)	180
	Dimensions (W) x (H) x (D)(mm)	135 x 230 x 36
Inner Carton	Packs / Inner ctn	12
	Net Weight(kg)	/
	Gross Weight(kg)	/
	Dimensions (L)x (W) x (H) (cm)	/
Outer Carton	Packs / Carton	48
	Net Weight(kg)	/
	Gross Weight(kg)	/
	Dimensions (L)x (W) x (H) (cm)	55 x 44.5 x 25.5
	Volume(cbm)	0.0625

### PS679



PS679-160CB



Accessory:  
USB Cable  
(L:30cm)



LED Status (● ON ○ OFF)	Capacity
● ● ● ●	76%-100%
○ ● ● ●	51%-75%
○ ○ ● ●	26%-50%
○ ○ ○ ●	<25%

#### Main Features

- Compatible with most mobile devices
- Auto On/Off capability
- Multiple safety protections (Short Circuit, Over Discharge, Over Charge, Over Current)
- LED indicator

#### Specifications

**Battery Capacity:** 16000mAh Lithium-ion battery 59.2Wh

**Power Input:** Micro USB 5V  $\pm$  2A

**Power Output:** max. (USB1: 5V  $\pm$  2A / USB2: 5V  $\pm$  1A)

#### Packaging

Box	Weight(g)	440
	Dimensions (W) x (H) x (D)(mm)	105 x 189 x 30
Inner Carton	Packs / Inner ctn	6
	Net Weight(kg)	/
	Gross Weight(kg)	/
	Dimensions (L)x (W) x (H) (cm)	21.4x19x13.2
Outer Carton	Packs / Carton	24
	Net Weight(kg)	10.5
	Gross Weight(kg)	11.4
	Dimensions (L)x (W) x (H) (cm)	40.2 x 23.2 x 28.9
	Volume(cbm)	0.027

Camelion USB Power Adapters offers you fast, reliable and efficient charging at home, office or during your travels. it comes in different sizes and all works with universal voltage, providing you the convenience of charging your mobile devices wherever you go.

## Power Supplies ▶ USB Power Adapters

### AD568

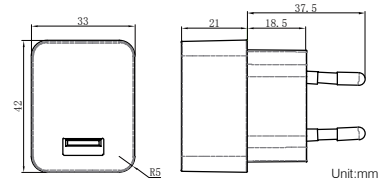

#### Main Features

- 1A direct power source for mobile devices
- Use any cable with charger
- Over current, overheating and short circuit protections
- Universal voltage

#### Specifications

**Input:** 100-240V~50/60Hz 150mA Max  
**Output:** 5V = 1A

#### Packaging

Blister	Plug:	TUV
	Weight(g)	64
	Dimensions (W) x (H) x (D)(mm)	107x171x65
Inner Carton	Packs / Inner ctn	24
	Net Weight(kg)	0.86
	Gross Weight(kg)	1.7
	Dimensions (L)x (W) x (H) (cm)	42.4x20.1x21.6
Outer Carton	Packs / Carton	48
	Net Weight(kg)	3
	Gross Weight(kg)	4.3
	Dimensions (L)x (W) x (H) (cm)	43.5x41.8x23.1
	Volume(cbm)	0.0420

### AD569

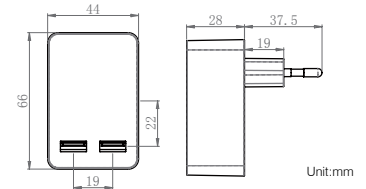

#### Main Features

- 3.4A output USB port for faster possible charging
- Dual USB output
- Direct power source for tablets and mobile devices
- Use any cable with charger
- Over current, overheating and short circuit protections
- Universal voltage

#### Specifications

**Input:** 100-240V~50/60Hz 430mA Max  
**Output:** 5V = 3.4A (2.4A+1A)

#### Packaging

Blister	Plug:	TUV	UL
	Weight(g)	116	112
	Dimensions (W) x (H) x (D)(mm)	107 x 171 x 70	107 x 171 x 67
Inner Carton	Packs / Inner ctn	24	24
	Net Weight(kg)	2.8	2.7
	Gross Weight(kg)	3.1	3.0
	Dimensions (L)x (W) x (H) (cm)	44.4 x 19.9 x 21.6	44.4 x 19.9 x 21.6
Outer Carton	Packs / Carton	48	48
	Net Weight(kg)	5.7	5.4
	Gross Weight(kg)	6.2	5.9
	Dimensions (L)x (W) x (H) (cm)	45.6 x 41.3 x 23.1	45.6 x 41.3 x 23.1
	Volume(cbm)	0.0435	0.0435

## ► USB Car Chargers

### DD802

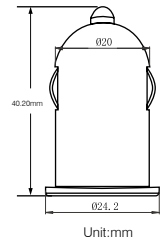
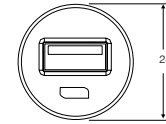

#### Main Features

- **USB Port For In-Car Power** Just plug it in and play.
- **5V 1A Power Output** Supports a wide range of mobile devices, such as iPhone®, PSP®, and other portable devices.
- **Short Circuit Protection** Reduces the risk of damage to your unit and the adapter in case of a short circuit.

#### Specifications

**Input:** 12 - 24V

**Power Output:** 5V  $\equiv$  1A

#### Packaging

Blister	Weight(g)	56.3
	Dimensions (W) x (H) x (D)(mm)	112 x 184 x 57
Inner Carton	Packs / Inner ctn	24
	Dimensions (L)x (W) x (H) (cm)	23.1 x 19.1 x 12.4
Outer Carton	Packs / Carton	48
	Net Weight(kg)	2.7
	Gross Weight(kg)	3.9
	Dimensions (L)x (W) x (H) (cm)	39.6 x 24.5 x 40
	Volume(cbm)	0.0388

### DD823A

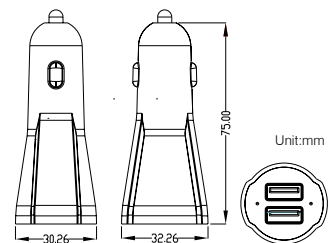

#### Main Features

- **Compatible with most mobile devices**
- **Dual-USB port design**
- **Max 2.4A fast charging**
- **Short circuit protections**

#### Specifications

**Input:** 12V - 24V  $\equiv$  1.3A Max

**Output:** 5V  $\equiv$  2.4A(1 x USB)

5V  $\equiv$  1A (2 x USB)

#### Packaging

Blister	Weight(g)	65
	Dimensions (W) x (H) x (D)(mm)	133 x 220 x 35
Inner Carton	Packs / Inner ctn	24
	Dimensions (L)x (W) x (H) (cm)	41.5 x 23.5 x 23.5
Outer Carton	Packs / Carton	48
	Net Weight(kg)	2.4
	Gross Weight(kg)	3.9
	Dimensions (L)x (W) x (H) (cm)	48.5 x 42.5 x 25
	Volume(cbm)	0.0516

# Power Supplies ▶ 3in1 USB Charging Kit

## AD568+DD811+CDC015

### 3in1 USB Charging Kit



AD568+DD811+CDC015-CB



### Main Features

#### USB Power Adapter

- 1A Direct power source for the mobile devices
- Compliant to any USB cable
- Over current, overvoltage and short circuit protection
- Universal voltage 100 - 240V

#### USB Car Charger

- Compatible with most mobile devices
- Short circuit protection

#### 2in1 USB Charging Cable

- Micro USB + 8pin Lightning
- Durable Nylon Cable
- Withstand bending
- Plug in/out (up to 3000 times)
- Compatible with 2.4A fast chargers

### Specifications

#### USB Power Adapter

**Input:** 100-240V ~ 50/60Hz 150A  
**Output:** 5V  $\overline{\text{---}}$  1.0A

#### USB Car Charger

**Input:** 12 - 24V  $\overline{\text{---}}$  1.3A (max)  
**Output:** 5V  $\overline{\text{---}}$  2.1A

### Packaging

Box	Plug:	UL/UK/TUV/SAA
	Weight(g)	105
Dimensions (W) x (H) x (D)(mm)	91 x 122 x 37	
Inner Carton	Packs / Inner ctn	10
	Net Weight(kg)	/
	Gross Weight(kg)	/
Dimensions (L)x (W) x (H) (cm)	20 x 19.5 x 12.8	
Outer Carton	Packs / Carton	40
	Net Weight(kg)	5.3
	Gross Weight(kg)	5.6
	Dimensions (L)x (W) x (H) (cm)	42.5 x 22 x 28.5
Volume(cbm)	0.0752	

## ► Device Chart

# Camelion®

BEST  YES  NO

USB Enable Devices		Power Bank		USB Power Adapters			USB Car Charger
		PS675	PS679	AD568	AD569	DD802	DD823
Mobile & Professional	iPhone 4/4S/5	✓	✓	✓	✓	✓	✓
	iPod®	✓	✓	✓	✓	✓	✓
	iPad®	✓	✓	✓	✓	✓	✓
	Samsung	✓	✓	✓	✓	✓	✓
	Sony	✓	✓	✓	✓	✓	✓
	HTC	✓	✓	✓	✓	✓	✓
	Blackberry®	✓	✓	✓	✓	✓	✓
	Nokia	✓	✓	✓	✓	✓	✓
	LG	✓	✓	✓	✓	✓	✓
	Sharp	✓	✓	✓	✓	✓	✓
	Motorola	✓	✓	✓	✓	✓	✓
	Smart Phone	✓	✓	✓	✓	✓	✓
	Portable Gaming Devices	✓	✓	✓	✓	✓	✓
	Tablet	✓	✓	✓	✓	✓	✓
Others	MP3/MP4/MP5	✓	✓	✓	✓	✓	✓
	Loudspeaker	✓	✓	✓	✓	✓	✓
	AM/FMRadio	✓	✓	✓	✓	✓	✓
	Digital Camera	✓	✓	✓	✓	✓	✓
	GPS	✓	✓	✓	✓	✓	✓
	USB battery charger	✓	✓	✓	✓	✓	✓
	Electronic shaver	✓	✓	✓	✓	✓	✓

**Remark:**

1. The capacity of the iPad battery must be not less than 5%.
2. Apply for USB 2.0 or lower version only.
3. Camelion accepts no responsibility for any accidents resulting from use of this information.



# Flashlights & Lanterns

---





## Main Features

- Powerful 3W COB LED illumination
- 360° rotatable stand for different lighting directions
- Strong magnet button to attach on metallic surface
- Non replace needed LED

## Specification

Power source: 4 x AAA battery  
 Light source: 3W COB LED  
 Luminous flux: 200LM\*  
 Constant operating time: 3 hrs  
 Lighting modes: On/Off  
 Dimensions: 91 x 35 x 128mm

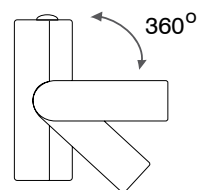
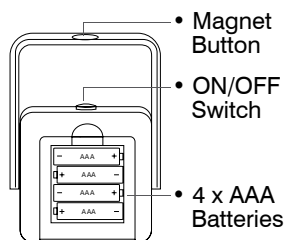

Adjustable stand



## Specifications

Model#	LEDs	LED Type	Luminous Flux	Battery Mode	Body Material	Available Colors	Water Resistant (Y/N)
S31	1	3W COB LED	200lm	4 x AAA	Plastic	Black	N

## Packaging Details

Item#	Packaging Type	Included Batteries	Blister/Box Details						Outer Carton Details					
			Dimensions (mm)			Net Weight (g)	Packs/ Carton	Dimensions (cm)			Volume (M³)	Gross Weight (Kg)	Net Weight (kg)	
			L Length	W Width	D Depth			L Length	W Width	H Height				
S31-4LR03D12	Display Box	4 x LR03	320	170	132	2046	48	36	34	29	0.0355	8.18	8.58	

## Flashlights & Lanterns ▶ LED Flashlights





### Classic Flashlights

- Super bright and replaceable LED bulb
- 35 lumens of light
- Long battery service life
- Many Color Options

#### Best for:

- Indoor & outdoor usage
- Household use

		Specifications					
Model #	Name	Bulb Type	Lumens	Battery Mode	Body Material	Available Colors	Water Resistant
FL1L2D	Classic Flashlights	LED	35lm	2 x D	Plastic	 Red Yellow Blue Black	N
FL1L2C	Classic Flashlights	LED	35lm	2 x C	Plastic	 Red Yellow Blue Black	N
FL1L2AA	Classic Flashlights	LED	35lm	2 x AA	Plastic	 Red Yellow Blue Black	N

**FL1L2D**

 **1 LED**



FL1L2D2R20P



FL1L2DD12



**FL1L2C**

 **1 LED**



FL1L2C2R14P



**FL1L2AA**

 **1 LED**



FL1L2AA2R6P



FL1L2AAD24



### Packaging Details

Item#	Name	Packaging Type	Included Batteries	Blister/Box Details			Net Weight (g)	Packs/ Carton	Outer Carton Details					
				Dimensions (mm)					Dimensions (cm)			Volume (M <sup>3</sup> )	Gross Weight (Kg)	Net Weight (kg)
				L Length	W Width	D Depth			L Length	W Width	D Depth			
FL1L2DB2R20P	Classic Flashlights	Blister Pack	2 x R20P	292	158	64	312	24	46	31.5	31	0.0449	9.0	7.5
FL1L2DD12		Display box	—	250	188	195	1332	4	51.5	40	21.5	0.0443	7.0	5.3
FL1L2CB2R14P	Classic Flashlights	Blister Pack	2 x R14P	240	131	50	170	24	47	26	20	0.0244	4.1	5.0
FL1L2AAB2R6P	Classic Flashlights	Blister Pack	2 x R6P	211	99	38	84	60	40	30	23	0.0276	6.0	5.3
FL1L2AAD24		Display box	—	230	154	150	1116	8	48	33	32.5	0.0515	10.5	8.9

# Flashlights & Lanterns ▶ Searchlamps



## 2-IN-1 Spotlight

- 3W high power LED and duo color COB
- 2-IN-1 multi-function lighting
- Five different lighting modes (Low Beam/ High Beam/White Light/ Red Light/ Red Flashing)
- Two-position side handle with a folding tail handle



## Multi-head LED Searchlamps

- **Powerful** Lights distances up to 150 meters\*
- **Cloverleaf Reflector System** for maximum focus and intensity
- **Energy Saving LEDS** up to 5 times brighter, 8 times more efficient than regular krypton bulbs\*
- **Long Service Life** Up to 500 hours continuous lighting\*
- **Never Replace LEDS** 100,000h LED lifetime
- **Handy Grip** with hooks, anti-roll design

*\*Camelion 2009 Lab Tests. Performance subject to battery (alkaline), temperature and ambient lighting conditions.*

### Best for:

- Indoor and/or outdoor use
- Military, security, campus, factory, emergency kits
- Vehicle use, garages, auto service use
- Handy for camping, travel, fishing

Model#	Specifications						
	LEDs	LED Type	Luminous Flux	Battery Mode	Body Material	Available Colors	Water Resistant (Y/N)
S32	1	3W COB LED	230lm	3 x AA	Plastic	■ Black	Y
FL-16LED	16	Super Bright LED	32lm	4 x D/ 1 x 4R25	Plastic	■ Yellow	Y
FL-9LED	9	Super Bright LED	18lm	4 x AA	Plastic	■ Yellow	Y
CM25L	1	Super Bright LED	45lm	1 x 4R25	Plastic	■ Yellow	Y



## 5 Lighting Modes

LED Search Lamp Modes:

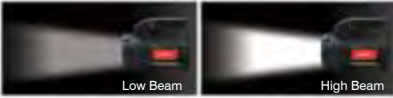

COB Area Lantern Modes:

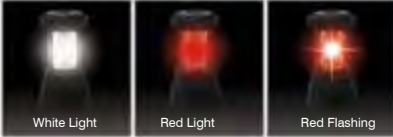

**S32**



S32-3R6PCB



**16LED**

**FL-16LED**



FL-16LED-4R20PCB



**9LED**

**FL-9LED**



FL-9LED-4R6P



**1LED**

**CM25L**



CM25L-4R25



### Packaging Details

Item#	Packaging Type	Included Batteries	Blister/Box Details				Outer Carton Details						
			Dimensions (mm)			Net Weight (g)	Packs/ Carton	Dimensions (cm)			Volume (M <sup>3</sup> )	Gross Weight (Kg)	Net Weight (kg)
			L Length	W Width	D Depth			L Length	W Width	D Depth			
S32-3R6PCB	Color Box	3 x R6P	185	105	148	350	6	38.5	33	16.8	0.0214	2.6	2.35
FL-16LED-4R20PCB	Box	4 x R20P	250	123	135	708	12	52	39	30	0.0608	10.6	9.6
FL-9LED-4R6P	Shrink pack	4 x R6P	100	146	110	278	36	59	54	24	0.0765	12.0	10
CM25L-4R25	Shrink pack	1 x 4R25	255	110	115	800	12	53	32.5	28.5	0.0491	12.5	9.6

## Flashlights & Lanterns ▶ LED Key Chain



### Super Bright

- Rubberized durable case
- Long Continuous Lighting up to 14hrs\*
- Super Bright in-built LED

Best for:  
Traveling, hiking, camping, fishing and athletics

Specifications							
Model#	LEDs	LED Type	Luminous Flux	Battery Mode	Body Material	Available Colors	Water Resistant (Y/N)
SL3013	1	white color LED	5lm	3 x LR44	Plastic	<div style="display: flex; flex-direction: column; gap: 5px;"> <div><span style="display: inline-block; width: 10px; height: 10px; background-color: yellow; border: 1px solid black;"></span> Yellow</div> <div><span style="display: inline-block; width: 10px; height: 10px; background-color: red; border: 1px solid black;"></span> Red</div> <div><span style="display: inline-block; width: 10px; height: 10px; background-color: green; border: 1px solid black;"></span> Green</div> <div><span style="display: inline-block; width: 10px; height: 10px; background-color: blue; border: 1px solid black;"></span> Blue</div> </div>	N

## SL3013

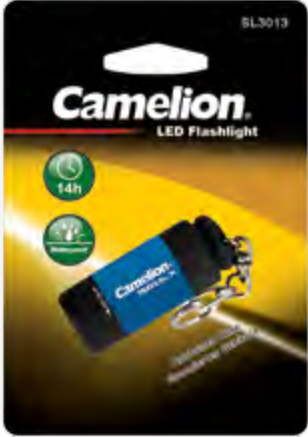
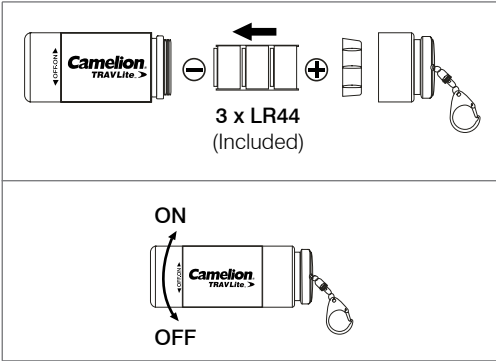

Packaging Details														
Item#	Packaging Type	Included Batteries	Blister/Box Details					Outer Carton Details						
			Dimensions (mm)			Net Weight (g)	Packs/ Carton	Dimensions (cm)			Volume (M <sup>3</sup> )	Gross Weight (Kg)	Net Weight (kg)	
			L Length	W Width	D Depth			L Length	W Width	H Height				
SL3013-3LR44BP	Blister Pack	3xLR44	167	155	103	26	192	32.5	31.5	45.5	0.0466	7.7	5.0	
SL3013-3LR44-PB36	Display Box	3xLR44	395	165	225	850	12	41.5	24.5	34.5	0.0347	11.0	10.2	

# Flashlights & Lanterns ▶ LED Flashlights

## ideal Lighting for Out of Doors



### LED Pocket Flashlight

- Ultra shock resistant up to 3 meters drop height
- Continuous lighting up to 20 hrs\*
- LED light source
- Water resistant (IPX4)\*\*
- Slim portable design

**Best for:**

Traveling, hiking, camping, fishing and athletics



### LED Rubber Flashlight

- Heavy Duty Rubberized Case
- Shockproof up to 2 meters drop
- Water Resistant (up to IPX7\*\*\*)
- Shatterproof Optical Lens
- Non Slip Grip oil/grease resistant grip with push button switch and end strap
- Never replace LEDs 100,000 hr lifetime
- Brightness Intensifying Optical Cavity Design

\*Camelion 2015 lab tests, LED brightness will attenuate when battery power is weak.

\*\*An IPX4 designation means it will withstand against rain and jets of water, but it not suitable nor guaranteed to survive for swimming or immerse under water.

\*\*\* An IPX7 designation means it can withstand accidental immersion in water within the depth of one meter for up to 30 minutes.

Specifications							
Model#	LEDs	LED Type	Luminous Flux	Battery Mode	Body Material	Available Colors	Water Resistant (Y/N)
HP7011	1	0.5W LED	45 lm	3 x AAA	Rubber	<div style="display: flex; gap: 5px;"> <span style="color: red;">■</span> Red                     <span style="color: green;">■</span> Green                 </div>	Y
PT1L2D	1	Superbright LED	45 lm	2 x D	Rubber	<div style="display: flex; gap: 5px;"> <span style="color: red;">■</span> Red                     <span style="color: blue;">■</span> Blue                 </div>	Y
PT1L2AA	1	Superbright LED	45 lm	2 x AA	Rubber	<div style="display: flex; gap: 5px;"> <span style="color: red;">■</span> Red                     <span style="color: blue;">■</span> Blue                 </div>	Y

## HP7011

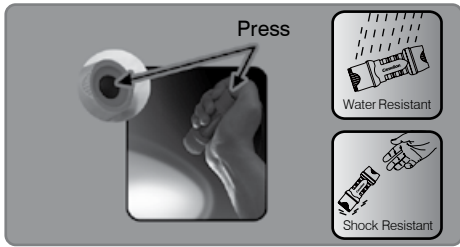

HP7011-3R03BP



## PT1L2D

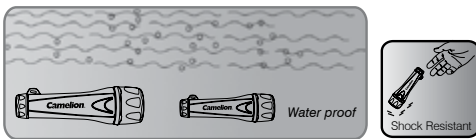

PT1L2D-2R20BP



## PT1L2AA



PT1L2AA-2R6PBP



### Packaging Details

Item#	Packaging Type	Included Batteries	Blister/Box Details					Outer Carton Details					
			Dimensions (mm)			Net Weight (g)	Packs/ Carton	Dimensions (cm)			Volume (M <sup>3</sup> )	Gross Weight (Kg)	Net Weight (kg)
			L Length	W Width	D Depth			L Length	W Width	H Height			
HP7011-3R03BP	Blister Pack	3R03P	190	110	40	96.5	48	51.5	21.5	26.5	0.0294	6.4	4.7
PT1L2D-2R20BP	Blister Pack	2 x 2R20P	305	175	70	446	24	50.5	45	33	0.0750	11.7	10.7
PT1L2AA-2R6PBP	Blister Pack	2 x R6P	248	120	50	161	48	49.5	36	33	0.0588	8.7	7.7



# Flashlights & Lanterns ▶ Penlights

## An Elegant Gift and a Handy Tool



- Powerful Spot Beam
- Durable Aircraft Aluminum
- Strong Pocket Clip
- Push Button Switch



### Best for:

- Useful tool for doctors
- Elegant, fashionable gift
- Great for hard to reach recesses and gaps



### Specifications

Model #	Name	Type of Bulb	Voltage/Ampere	Battery Mode	Body Material	Available Colors	Water Resistant
DL2AAAS	Penlight Flashlight	Vakuum	2.2V/250mA	2AAA	Aircraft aluminum	☐ Silver	N

### Packaging Details

Item#	Packaging Type	Included Batteries	Blister/Box Details				Outer Carton Details						
			Dimensions (mm)			Net Weight (g)	Packs/ Carton	Dimensions (cm)			Volume (M <sup>3</sup> )	Gross Weight (Kg)	Net Weight (kg)
			L Length	W Width	D Depth			L Length	W Width	H Height			
DL2AAAS	Blister Pack	2 x R03P	200	155	115	56	100	48.5	39.0	25.0	0.0479	5.6	7.0

## 3W COB LED

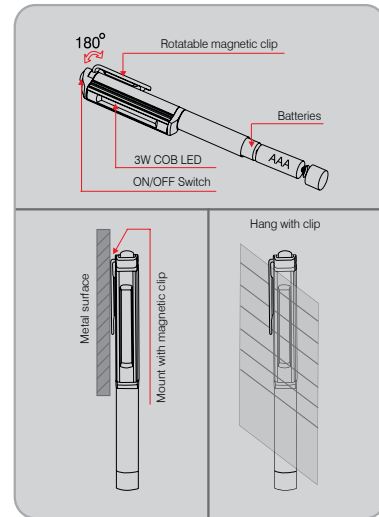

- Powerful 3W COB lighting
- Durable CNC-machined aluminum alloy body
- Rotatable magnetic clip
- None replace needed LED of up to 50,000 hours lifespan



T11-3R03PD12



4 260216 456244

### Specifications

Model#	LEDs	LED Type	Luminous Flux	Battery Mode	Body Material	Available Colors	Water Resistant (Y/N)
T11	1	3W COB LED	200lm	3 x AAA	Aluminum	<ul style="list-style-type: none"> <li><span style="color: blue;">■</span> Blue</li> <li><span style="color: red;">■</span> Red</li> <li><span style="color: silver;">■</span> Silver</li> </ul>	N

### Packaging Details

Item#	Packaging Type	Included Batteries	Blister/Box Details					Outer Carton Details					
			Dimensions (mm)			Net Weight (g)	Packs/ Carton	Dimensions (cm)			Volume (M³)	Gross Weight (Kg)	Net Weight (kg)
			L Length	W Width	D Depth			L Length	W Width	H Height			
T11-3R03PD12	Display Box	3 x R03P	202	125	40	94	48	58	36.5	22.5	0.0477	5.5	4.5

# Flashlights & Lanterns ▶ CT-Series LED Flashlights

## Best Lighting for Outdoors



### High grade aluminium flashlight with maximum illumination

- High Performance Chip Module SMD Technology
- Unbreakable Anodized Aluminium Alloy
- Ultra-High Luminosity

**Best for:**

- Security, police, military, emergency response
- Ideal for work, outdoor and general purpose activities

Specifications								
Model #	Name	LEDs	LED Type	Lumens	Battery Mode	Body Material	Available Colors	Water Resistant
CT4004	9 LED Flashlight	9	LED Technology	120lm	3 x AAA	Aluminium	■ Black □ Silver	N

**CT4004**

**9 LED**



CT4004



4 260030 255733

		Packaging Details												
Item#	Name	Packaging Type	Included Batteries	Blister/Box Details				Outer Carton Details						
				Dimensions (mm)			Net Weight (g)	Packs/ Carton	Dimensions (cm)			Volume (M <sup>3</sup> )	Gross Weight (Kg)	Net Weight (kg)
				L Length	W Width	D Depth			L Length	W Width	D Depth			
CT4004	9 LED Flashlight	Double blister	3 x R03P	244	123	40	149.9	120	51	38	56	0.1085	20	19

## Flashlights & Lanterns ▶ Head Lights



Camelion Head lights is equipped with superb light brightness and durability, each has a specialty of its own. While both of these head light have different choice of lighting mode, making it a great choice for work environments, fishing, hunting, and other outdoor or indoor activities.

### S58

#### 3W COB LED Headlight

- Powerful COB - up to 120Lm
- Long Lifespan LED - efficient and durable
- Three Lighting Modes - for various conditions
- Adjustable Angle - for perfect lighting directions
- Economical – powered by 3 AAA batteries

#### Best for:

Camping, Outdoors, Caving

### CT4007

#### 3 Watt Headlight

- High Performance Chip Module SMD Technology
- Low Power Consumption
- Ultra-High Luminosity
- 3 different LED mode

Model#	LED Type	Luminous Flux	Battery Mode	Body Material	Available Colors	Water Resistant (Y/N)
S58	3W COB LED	120lm	3 x AAA	Plastic	■ Black	N
CT4007	High-power-chip SMD Technology	130lm	3 x AAA	Plastic	■ Black	N



S58

## 3W COB LED Headlight



3 Lighting Modes:



S58-3LR03DB



4 260216 457142

CT4007

## 3 Watt Headlight



CT4007



4 260030 255764

### Packaging Details

Item#	Packaging Type	Included Batteries	Blister/Box Details				Outer Carton Details						
			Dimensions (mm)			Net Weight (g)	Packs/ Carton	Dimensions (cm)			Volume (M <sup>3</sup> )	Gross Weight (Kg)	Net Weight (kg)
			L Length	W Width	D Depth			L Length	W Width	H Height			
S58-3LR03DB	Double blister	3xLR03	285	210	268	99.5	48	55	43.5	30.5	0.0729	5.7	4.78
CT4007	Double blister	3 x LR03	245	125	100	150.5	100	52	38	58.5	0.1156	15.5	13.5

# Flashlights & Lanterns ▶ Work Lights

## Ideal Lighting for Workplace





### Work Light + Multi Light 2 in 1

- Outstanding illumination provided by 3W COB LED
- Strong magnet button and 360 degrees swivel hook
- Durable rubberized ABS casing for better comfort

**Best for:**

Professionals, home and office use.

Model#	LED Type	Luminous Flux	Battery Mode	Body Material	Available Colors	Water Resistant (Y/N)
SL5240N	3W COB LED	220lm	3 x AA	Plastic	 Black+Red	N
SL7280N	3W COB LED	200lm	3 x AAA	Plastic	 Black+Red	N

## Work Light



### SL5240N 3W COB LED



SL5240N-3R6PD12



## Multi Light 2 in 1



### SL7280N 3W COB LED



SL7280N-3R03PD12



### Packaging Details

Item#	Packaging Type	Included Batteries	Blister/Box Details				Outer Carton Details						
			Dimensions (mm)			Net Weight (g)	Packs/ Carton	Dimensions (cm)			Volume (M <sup>3</sup> )	Gross Weight (Kg)	Net Weight (kg)
			L Length	W Width	D Depth			L Length	W Width	H Height			
SL5240N-3R6PD12	Display Box	3xR6P	202	227	210	1750	4	49	24	46	0.0541	9.0	7.0
SL7280N-3R03PD12	Display Box	3xR03P	158	305	96	1250	4	32.5	32	21.5	0.0224	5.0	4.2

# Flashlights & Lanterns ▶ Professional Work Lights



Best for: Professionals, Camping, Outdoors, Caving use

## S20

### Main Features

- Powerful 8W COB LED illumination
- Two lighting modes - high beam / low beam
- 360° rotatable bracket, can adjust to any direction, convenient to hand carry or put on table
- Special coating applied, for a better appearance and smoother to handle
- Long Lifespan COB: needs no replacement, extremely energy saving

### Specifications

- Power Source: Li-ion 18650, 3.7V, 4000mAh
- Light Source: 8W COB LED
- Luminous Flux:  
High: 500LM Low: 300LM
- Continuous Operating Time:  
High: 2hrs Low: 5hrs
- Dimensions: 225 x 195 x 58mm
- Accessories: USB charging cable L=1.2M

## S21

### Main Features

- Rechargeable - powered by a built-in rechargeable 2200mAh Li-ion battery pack
- Portable and Lightweight - equipped with a handle and a detachable stand, easy to carry, place it with the stand or hanging for camping
- Weatherproof - excellent outdoor performance with 360° rotating and weatherproof function
- Adjustable handle and stand - 360° rotatable, can easily be adjusted according to your requirements

### Specifications

- Power Source: Li-ion 18650, 7.4V, 2200mAh
- Input: DC 8.4V, 1A max
- Charging Time: Approx. 3hrs
- Light Source: 10W COB
- Color Temperature: 6000K - 6500K
- Luminous Flux: 800LM
- Beam Angle: 120°
- Running Time: 4hrs
- Ingress Protection: IP65
- Dimension: 123 x 132 x 250mm
- Accessories: wall charger and car charger

## S22

### Main Features

- Rechargeable - powered by a built-in rechargeable 4400mAh Li-ion battery pack
- Portable and Lightweight - equipped with a handle and a detachable stand, easy to carry, place it with the stand or hanging for camping
- Weatherproof - excellent outdoor performance with 360° rotating and weatherproof function
- Adjustable handle and stand - 360° rotatable, can easily be adjusted according to your requirements

### Specifications

- Power Source: Li-ion 18650, 7.4V, 4400mAh
- Input: DC 8.4V, 1A max
- Charging Time: Approx. 6hrs
- Light Source: 20W COB
- Color Temperature: 6000K - 6500K
- Luminous Flux: 1600LM
- Beam Angle: 120°
- Running Time: 4hrs
- Ingress Protection: IP65
- Dimension: 163 x 163 x 300mm
- Accessories: wall charger and car charger

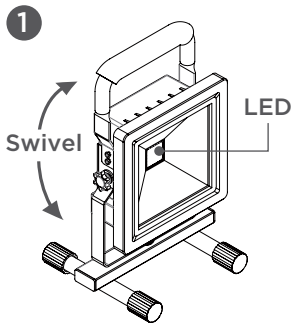

S22



S22-CB

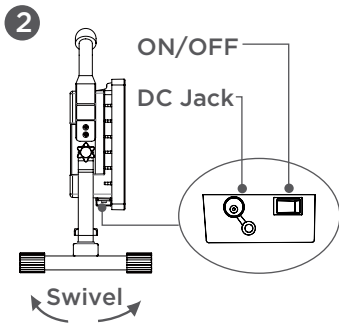

S21



S21-CB

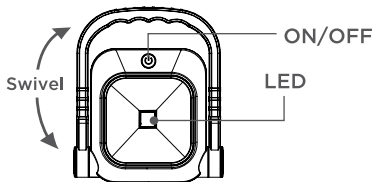

S20



S20-CB



Model#	LED Type	Luminous Flux	Battery Mode	Body Material	Available Colors	Water Resistant (Y/N)
S20	8W COB LED	500lm	Li-ion 18650	Plastic	Black	N
S21	10W COB LED	800lm	Li-ion 18650	Plastic	Yellow	Y
S22	20W COB LED	1600lm	Li-ion 18650	Plastic	Red	Y

### Packaging Details

Item#	Packaging Type	Included Batteries	Blister/Box Details					Outer Carton Details					
			Dimensions (mm)			Net Weight (g)	Packs/ Carton	Dimensions (cm)			Volume (M³)	Gross Weight (Kg)	Net Weight (kg)
			L Length	W Width	D Depth			L Length	W Width	H Height			
S20-CB	Color Box	Li-ion 18650	205	75	240	600	12	47	42.5	26	0.0519	7.7	7.2
S21-CB	Color Box	Li-ion 18650	130	110	225	1100	12	45.5	40.5	24.5	0.0451	14.2	13.2
S22-CB	Color Box	Li-ion 18650	170	120	270	1600	10	61.5	35.5	29	0.0633	17	16



# Flashlights & Lanterns ▶ Domestic Lighting

## Ideal Lighting for Household

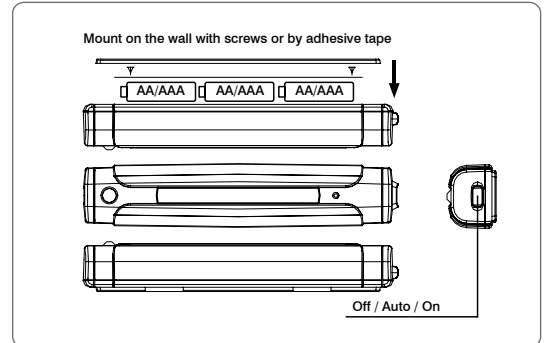

### Sensor Light

- Wide Sensory Angles
- Long sensory distance
- Choice of installation by adhesive tape or screws
- Detachable body from the mounted base

### Best for:

Bedrooms, hallways, Staircase, washroom, closets and drawers



SL7018-3R6TB



4 260216 456312 1

### Specifications

Model#	Bulb Type	Luminous Flux	Battery Mode	Body Material	Available Colors	Water Resistant (Y/N)
SL7018	Super Bright LED	15lm	3 x AA	Plastic	☐ White	N

### Packaging Details

Item#	Packaging Type	Included Batteries	Blister/Box Details				Outer Carton Details						
			Dimensions (mm)			Net Weight (g)	Packs/ Carton	Dimensions (cm)			Volume (M <sup>3</sup> )	Gross Weight (Kg)	Net Weight (kg)
			L Length	W Width	D Depth			L Length	W Width	H Height			
SL7018-3R6TB	Blister Pack	3 x R6P	190	110	48	139	48	52.5	44.5	21.5	0.0502	7.9	6.7

## ► Flashlights Replacement Bulbs

### LED



**3V**  
**4.5V**  
**6V**

### Specifications

Model No.	Lamp Type	Voltage (V)	Current (mA)	Power (W)	Luminous Flux (lm)	Color Temperature (K)	Base Type	Average Life (hrs)	Battery Type
BL304 WN	LED Flashlight Bulb	3.0	130	0.4	30	6000--8000 (Cool White)	P 13.5S	10,000	2x(AA/AAA/D/C)
BL406 WN	LED Flashlight Bulb	4.5	130	0.6	38	6000--8000 (Cool White)	P 13.5S	10,000	3x(AA/AAA/D/C) 3LR12,3R12
BL608 WN	LED Flashlight Bulb	6.0	130	0.8	42	6000--8000 (Cool White)	P 13.5S	10,000	4x(AA/AAA/D/C), 4R25

### Packaging Details

Item #	Name	Packaging Type	Blister/Box Details				Outer Carton Details						
			Dimensions (mm)			Net Weight (g)	Packs/ Carton	Dimensions (cm)			Volume (M <sup>3</sup> )	Gross Weight (Kg)	Net Weight (kg)
			L Length	W Width	D Depth			L Length	W Width	D Depth			
BL304WN-BP1	LED Replacement Bulbs	Blister Pack	92	55	14	6	480	30.5	30	24.8	0.0227	4.4	2.4
BL406WN-BP1			92	55	14	6	480	30.5	30	24.8	0.0227	4.4	2.4
BL608WN-BP1			92	55	14	6	480	30.5	30	24.8	0.0227	4.4	2.4

# Promotional Accessories

---

---



## Sales Promotional Material

### Maximum Impact, Minimum Space, Optimal Sales

When you want your Camelion products to have maximum impact you need optimal POP promotional material.

For the latest sales accessories and premiums please contact us at [info@camelion.com](mailto:info@camelion.com)



WCD-02

WCD-03

WCD-05

### Metal Counter Display

WCD-02: 33 x 43 x 22cm (6 hooks)

WCD-03: 33 x 58 x 22cm (9 hooks)

WCD-05: 44 x 66 x 20cm (12 hook)

- Sturdy steel construction for long use
- Easy to see, easy to reach
- Light weight for easy portability
- Available in Metal Black



### Metal Counter Display

MFD-02

- Use metal racks to expand each peg
- Professional slim and elegant design
- Rugged steel construction for long life
- Easy assembly by interlocking joints, no screws or hammers (Instructions included)
- W x H x D: 46 x 70 x 26cm



### Metal Floor Display

WCD-06

- 10 Racks 20 hooks L = 12,5cm
- Simple and lightweight design
- Dimensions: W x H x D: 30x158x35cm

#### Qty for Each Hook:

AAA Size: 10packs

AA Size: 7packs

9V Size: 6packs

C Size: 5packs

D Size: 4packs



### Metal Floor Display

MFD-03

- Up to 300-400 peg holes (ideally holds 20-30 large / medium size packages)
- Use metal racks to expand each peg
- Professional slim and elegant design
- Rugged steel construction for long life
- Easy assembly by interlocking joints, no screws or hammers (Instructions included)
- W x H x D: 80x180x61cm



### Metal Floor Display

MFD-06

**Rugged steel construction for long life**

With this display you present your Camelion products appealing and clear. The lightly curved floor display focusses attention directly to the product assortment, and moreover emphasizes the Camelion brand - a major boost for a positive purchase decision.

B x H x T: 107 x 177 x 33cm



DR-11



DR-12

### Battery Aisle Display Box

- Battery shaped floorstand trigger and strengthen brand recognition
- Brand space maximized through strong printed graphics
- Strong structural integrity for easy moving
- Ideal for most retail markets placement
- DR11: W x H x D: 60 x 158 x 31 cm
- DR12: W x H x D: 42 x 70.5 x 21 cm

# Promotional Accessories

## Display Box



### DR16 Promotion Display "8+4 free"

- Plus Alkaline floor display for promotion blister "8+4 free" (AA I AAA)
- High (total) 1,17m + pallet
- Width 0,55m
- Depth 0,38m
- Material Cardboard
- Surface shiny
- 12x grids = 12 storage compartments
- 48x LR6 „8+4 free“ (8 storage compartments)  
6 blister per storage compartment
- 36 x LR03 „8+4 free“ (4 storage compartments)
- 84 blister total



Plus Alkaline LR6 BP8+4  
Art. Nr. 110 84006  
EAN 4260216453915  
carton 48 / innerbox 6



Plus Alkaline LR03 BP8+4  
Art. Nr. 110 84003  
EAN 4260216453922  
carton 72 / innerbox 6



### DR16 Promotion Display "24"

- Plus Alkaline floor display for plastic box "24" (AA I AAA)
- High (total) 1,17m + pallet
- Width 0,55m
- Depth 0,38m
- Material Cardboard
- Surface shiny
- 32x grids = 32 storage compartments
- 60 x LR6 „24“ (20 storage compartments)  
3 boxes per storage compartment
- 48 x LR03 „24“ (12 storage compartments)  
4 boxes per storage compartment
- 108 boxes total



Plus Alkaline LR6 PB24  
Art. Nr. 111 02406  
EAN 4260033150455  
carton 30 / innerbox 6



Plus Alkaline LR03 PB24  
Art. Nr. 111 02403  
EAN 4260033150462  
carton 30 / innerbox 6



### DR16 Promotion Display "40"

- Plus Alkaline floor display for promotion shrink "SP40" (AA I AAA)
- High (total) 1,17m + pallet
- Width 0,57m
- Depth 0,38m
- Material Cardboard
- Surface shiny
- 126 x LR6/AA SP40  
3 Rows x 6 x 7 Packs = 126 Packs
- 64 x LR03/AAA SP40  
1 Row x 8 x 8 Packs = 64 Packs
- 190 Packs total



Plus Alkaline LR6/AA SP40  
Art. Nr. 11104006  
EAN 4260216456428  
carton 12



Plus Alkaline LR03/AAA SP40  
Art. Nr. 11104003  
EAN 4260216456435  
carton 16





HW-01



HW-03



HW-04



HW-05



HW-06



HW-07



## Following Racks

**HW-01** 5 Metal Hook Racks  
W x H: 10 x 75 cm

**HW-03** 5 Black Plastic Hook Racks  
W x H: 7 x 70 cm

**HW-04** 12 Clear Plastic Hook Racks  
W x H: 7.5 x 62 cm

**HW-05** 12 White Plastic Hook Racks  
W x H: 6.2 x 77.5 cm

**HW-06** 12 Black Plastic Hook Racks  
W x H: 84 x 11.3 cm

**HW-07** 12 Clear Plastic Hook Racks  
W x H: 84 x 11.3 cm



### Ball Pen

PN-04R



### Ball Pen

PN-04B



### Paper Bag

PB-01

- Material: paper
- W x H x D: 54x14x44.5cm



### Non Woven Bag

HB-04

- Material: fiber
- W x H x D: 38x34x10cm



### Caps

C-01

Comfortable golf caps with all-size fits design, in trendy corporate colors.

# Camelion catalogue 2020 register

PAGE	PRODUCT	Art.No.	EAN Barcode	PAGE	PRODUCT	Art.No.	EAN Barcode	PAGE	PRODUCT	Art.No.	EAN Barcode
<b>LITHIUM P7 / 9V LITHIUM BATTERIES</b>				14	R14P-BP2B	102 00214	4260033151025	19	CR2477-BP1	130 01477	4260216455353
6	FR6-BP2	190 00206	4260033154859	14	R6P-BP4B	102 00406	4260033151049	19	CR927-BP1	130 01927	4260216452475
6	FR03-BP2	190 00203	4260033154873	14	R03P-BP4B	102 00403	4260033151070	19	CR1216-BP5	130 05216	4260033152718
6	ER9V-BP1	190 00122	4260216450334	14	R6P-HP12B	102 01206	4260033151438	19	CR1220-BP5	130 05122	4260033152701
6	ER9V-SP1	191 00122	4260216455599	14	6F22-BP1B	102 00122	4260033151094	19	CR1225-BP5	130 05225	4260033152695
<b>DIGI ALKALINE / BLISTER</b>				<b>SUPER HEAVY DUTY GREEN</b>				19	CR1616-BP5	130 05161	4260033152688
7	LR20-BP2DG	112 10220	4260216453885	14	R20-BP2G	100 00220	4260033156280	19	CR1620-BP5	130 05620	4260033152671
7	LR14-BP2DG	112 10214	4260216453892	14	R20-BP4G	100 00420	4260033156358	19	CR1632-BP5	130 05632	4260216455797
7	LR6-BP4DG	112 10406	4260033154521	15	R14-BP2G	100 00214	4260033156297	19	CR2016-BP5	130 05016	4260033152664
7	LR6-BP2DG	112 10206	4260033154538	15	R14-BP4G	100 00414	4260033156389	19	CR2025-BP5	130 05025	4260033152657
7	LR03-BP4DG	112 10403	4260033154545	15	R14-BP6G	100 00614	4260033150936	19	CR2032-BP5	130 05032	4260033152640
7	LR03-BP2DG	112 10203	4260033154552	15	R6-BP8G	100 00806	4260033156402	19	CR2430-BP5	130 05430	4260216455803
7	6LR61-BP1DG	112 10122	4260216454028	15	R6-BP4G	100 00406	4260033156303	19	CR2450-BP5	130 05450	4260216455810
<b>PLUS ALKALINE</b>				15	R6-BP10G	100 01006	4260033156396	19	CRVP01-BP6	130 00600	4260216456145
8	LR20-BP2	110 00220	4260033150004	15	R03-BP4G	100 00403	4260033156327	<b>MICRO BATTERIES ALKALINE</b>			
8	LR14-BP2	110 00214	4260033150011	15	R03-BP8G	100 00803	4260033156426	20	AG1-BP2 (0%HG)	120 50201	4260216454783
8	LR6-BP4	110 00406	4260033150028	15	6F22-BP1G	100 00122	4260033156341	20	AG2-BP2 (0%HG)	120 50202	4260216454790
8	LR6-BP2	110 00206	4260033150035	15	6F22-BP2G	100 00222	4260033156365	20	AG3-BP2 (0%HG)	120 50203	4260216454806
8	LR03-BP4	110 00403	4260033150042	16	3R12-BP1G	100 00112	4260033156372	20	AG4-BP2 (0%HG)	120 50204	4260216454622
8	LR03-BP2	110 00203	4260033150059	16	R20-SP2G	101 00220	4260033156433	20	AG5-BP2 (0%HG)	120 50205	4260216454813
8	4+4LR6	110 44806	4260216451096	16	R14-SP2G	101 00214	4260033156440	20	AG6-BP2 (0%HG)	120 50206	4260216454820
8	4+4LR03	110 44803	4260216451102	16	R6-SP2G	101 00206	4260033156464	20	AG7-BP2 (0%HG)	120 50207	4260216454837
9	LR6-BP10	110 01006	4260033150097	16	R6-SP4G	101 00406	4260033156457	20	AG8-BP2 (0%HG)	120 50208	4260216454844
9	LR03-BP10	110 01003	4260033150103	16	R03-SP2G	101 00203	4260033156488	20	AG9-BP2 (0%HG)	120 50209	4260216454851
9	LR6-HP12	110 01206	4260033150424	16	R03-SP4G	101 00403	4260033156471	20	AG10-BP2 (0%HG)	120 50210	4260216454608
9	6LR61-BP1	110 00122	4260033150066	16	6F22-SP1G	101 00122	4260033156495	20	AG11-BP2 (0%HG)	120 50211	4260216454868
9	LR1-BP2	110 00201	4260033150080	16	3R12-SP1G	10100112	4260033156501	20	AG12-BP2 (0%HG)	120 50212	4260216454875
9	LR1-BP5	110 00501	4260216455780	17	4R25-SP1G	10100125	4260033156211	20	AG13-BP2 (0%HG)	120 50213	4260216454615
9	LR61-BP2	110 00261	4260033150295	17	FPG-GB40	101 00400	4260033150905	20	625A-BP2 (0%HG)	120 50125	4260216454882
9	3LR12-BP1	110 00112	4260033150073	17	4+2R6PG-BP	100 42606	4260216456138	20	AG0-BP10 (0%HG)	120 51000	4260216454899
9	LR6 bulk	110 90006	-	17	4+2R03PG-BP	100 42603	4260216456121	20	AG1-BP10 (0%HG)	120 51001	4260216454905
9	LR03 bulk	110 90003	-	17	R6-SP8G	101 08006	4260216451118	20	AG2-BP10 (0%HG)	120 51002	4260216454912
10	LR6-SP40HFB	111 04006	4260216456428	17	R03-SP8G	101 08003	4260216451188	20	AG3-BP10 (0%HG)	120 51003	4260216454929
10	LR03-SP40HFB	111 04003	4260216456435	17	R6-SP12G	101 01206	4260033156266	20	AG4-BP10 (0%HG)	120 51004	4260216454400
10	LR6-SP2	111 00206	4260033150332	17	R03-SP12G	101 01203	4260216451199	20	AG5-BP10 (0%HG)	120 51005	4260216454936
10	LR6-SP4	111 00406	4260033150325	17	R6P-PB24G	101 02406	4260033157454	20	AG6-BP10 (0%HG)	120 51006	4260216454943
10	LR03-SP2	111 00203	4260033150356	17	R03P-PB24G	101 02403	4260033157447	20	AG7-BP10 (0%HG)	120 51007	4260216454950
10	LR03-SP4	111 00403	4260033150349	<b>PHOTO LITHIUM BATTERIES</b>				20	AG8-BP10 (0%HG)	120 51008	4260216454967
10	LR14-SP2	111 00214	4260033150318	18	CR123A-BP1	190 01123	4260033153364	20	AG9-BP10 (0%HG)	120 51009	4260216454974
10	LR20-SP2	111 00220	4260033150301	18	CR123A-BP2	190 02123	4260216456688	20	AG10-BP10 (0%HG)	120 51010	4260216454981
10	6LR61-SP1	111 00122	4260033150363	18	2CR5-BP1	190 01125	4260033153395	20	AG11-BP10 (0%HG)	120 51011	4260216454998
10	3LR12-SP1	111 00112	4260033150370	18	CR-P2-BP1	190 01152	4260033153371	20	AG12-BP10 (0%HG)	120 51012	4260216455001
11	LR6-PB24	111 02406	4260033150455	18	CR2-BP1	190 01142	4260033153388	20	AG13-BP10 (0%HG)	120 51013	4260216455018
11	LR03-PB24	111 02403	4260033150462	<b>MICRO BATTERIES LITHIUM</b>				21	A11-BP1(0%HG)	110 50111	4260216455049
11	LR6-PB20	111 02006	4260216453106	19	CR1216-BP1	130 01216	4260033152831	21	A23-BP1(0%HG)	110 50123	4260216455056
11	LR03-PB20	111 02003	4260216453113	19	CR1220-BP1	130 01122	4260033152824	21	A27-BP1(0%HG)	110 50127	4260216455063
11	6LR61-PB6	111 00622	4260033150479	19	CR1225-BP1	130 01225	4260033152817	21	A32-BP1(0%HG)	110 50132	4260216455070
11	LR6-PBH24	111 12406	4260033155092	19	CR1616-BP1	130 01161	4260033152800	21	A23-BP5(0%HG)	110 50523	4260216455087
11	LR03-PBH24	111 12403	4260033155108	19	CR1620-BP1	130 01620	4260033152794	21	A27-BP5(0%HG)	110 50527	4260216455094
11	CM-FA-01	111 00029	4260033155160	19	CR1632-BP1	130 01632	4260033152923	21	4LR44-BP1 (0%HG)	120 50144	4260216455025
12	LR6-SP10-DA	111 01006	4260033157249	19	CR2016-BP1	130 01016	4260033152787	21	4LR44-BP5 (0%HG)	120 50544	4260216455827
12	LR03-SP10-DA	111 01003	4260033157256	19	CR2025-BP1	130 01025	4260033152770	21	4LR44-BP1 (0%HG)	120 00143	4260216455025
<b>LIMITED EDITION</b>				19	CR2032-BP1	130 01032	4260033152763	<b>HEARING AID ZINC AIR</b>			
12	10+2-LR6-DA	111 01206	4260216456443	19	CR2320-BP1	130 01320	4260033152756	22	A13-BP6 (0%HG)	150 56013	4260030253975
12	10+2-LR03-DA	111 01203	4260216456650	19	CR2330-BP1	130 01330	4260033152749	22	A10-BP6 (0%HG)	150 56010	4260030253968
13	8+4LR6-BP	110 84006	4260216453915	19	CR2325-BP1	130 01325	4260033152848	22	A675-BP6 (0%HG)	150 56675	4260030253999
13	8+4LR03-BP	110 84003	4260216453922	19	CR2430-BP1	130 01430	4260033152732	22	A312-BP6 (0%HG)	150 56312	4260030253982
<b>SUPER HEAVY DUTY BLUE</b>				19	CR2450-BP1	130 01450	4260033152725				
14	R20P-BP2B	102 00220	4260033151018								

PAGE	PRODUCT	Art.No.	EAN Barcode
<b>SILVER OXIDE</b>			
22	SR41-BP1 (0%HG)	140 51041	4260216455117
22	SR43-BP1 (0%HG)	140 51043	4260216455124
22	SR44-BP1 (0%HG)	140 51044	4260216455131
22	SR54-BP1 (0%HG)	140 51054	4260216455148
22	SR57-BP1 (0%HG)	140 51057	4260216455155
22	SR58-BP1 (0%HG)	140 51058	4260216455162
22	SR59-BP1 (0%HG)	140 51059	4260216455179
22	SR60-BP1 (0%HG)	140 51060	4260216455186
22	SR63-BP1 (0%HG)	140 51063	4260216455193
22	SR66-BP1 (0%HG)	140 51066	4260216455209
22	SR69-BP1 (0%HG)	140 51069	4260216455216
22	SR41-BP5 (0%HG)	140 55041	4260216455223
22	SR43-BP5 (0%HG)	140 55043	4260216455230
22	SR44-BP5 (0%HG)	140 55044	4260216455247
22	SR54-BP5 (0%HG)	140 55054	4260216455254
22	SR57-BP5 (0%HG)	140 55057	4260216455261
22	SR58-BP5 (0%HG)	140 55058	4260216455278
22	SR59-BP5 (0%HG)	140 55059	4260216455285
22	SR60-BP5 (0%HG)	140 55060	4260216455292
22	SR63-BP5 (0%HG)	140 55063	4260216455308
22	SR66-BP5 (0%HG)	140 55066	4260216455315
22	SR69-BP5 (0%HG)	140 55069	4260216455322
22	4SR44-BP1 (0%HG)	140 51444	4260216455032
22	4SR44-Bulk (0%HG)	140 52444	-
<b>BATTERY ADAPTER &amp; CASES</b>			
23	Battery Case for 4 x AAA / AA Batteries & Rechargeable	500 00001	4260033157539
23	Battery Case for 4 x AAA / AA Batteries & Rechargeable	500 00002	4260216452536
23	Plastic Box for 24x AA PB24	501 00017	-
23	Plastic Box for 24x AAA PB24	501 00018	-
23	Adapter Plastic for C size (Color: white)	999 00014	4260033157546
23	Adaptor Plastic for D size / D (Color: white)	999 00020	4260033157553
<b>BATTERY TESTER</b>			
23	BT-503	203 00503	4260033157508
23	BT-507	203 00507	4260216457128
<b>ALWAYS READY</b>			
26	NH-AA2500ARBP2	174 25206	4260216453038
26	NH-9V200ARBP1	174 20122	4260033155221
26	NH-AA2300ARBP2	174 23206	4260033152336
26	NH-AA2300ARBP4	174 23406	4260033154040
26	NH-AAA800ARBP2	174 08203	4260033152305
26	NH-AAA800ARBP4	174 08403	4260033152312
27	NH-AA800ARBP2	174 08206	4260216453236
27	NH-AA600ARBP4(GSL)	174 06406	4260216455667
27	NH-AAA600ARBP4(GSL)	174 06403	4260216455674
<b>NI-MH RECHARGEABLE BATTERIES</b>			
28	NH-D10000BP2	170 10220	4260033151865
28	NH-D7000BP2	170 70220	4260033151520
28	NH-D2500BP2	170 25220	4260033151537
28	NH-C3500BP2	170 35214	4260033151544
28	NH-C2500BP2	170 25214	4260033151551
28	NH-AA2700BP4	170 27406	4260033151933
28	NH-AA2700BP2	170 27206	4260033151926
29	NH-AA2500BP4	170 25406	4260033151834

PAGE	PRODUCT	Art.No.	EAN Barcode
29	NH-AA2500BP2	170 25206	4260033151827
29	NH-AA2300BP4	170 23406	4260033151742
29	NH-AA2300BP2	170 23206	4260033151735
29	NH-AA2000BP2	170 20206	4260033151582
29	NH-AA1800BP4	170 18406	4260033151612
29	NH-AA1800BP2	170 18206	4260033151605
29	NH-AA1500BP2	170 15206	4260033151629
30	NH-AAA1100BP4	170 11403	4260033151957
30	NH-AAA1100BP2	170 11203	4260033151940
30	NH-AAA1000BP4	170 10403	4260033151889
30	NH-AAA1000BP2	170 10203	4260033151872
30	NH-AAA900BP4	170 09403	4260033151766
30	NH-AAA900BP2	170 09203	4260033151759
30	NH-AAA800BP2	170 08203	4260033151667
31	NH-AAA600BP4	170 06403	4260033151711
31	NH-AAA600BP2	170 06203	4260033151704
31	NH-9V250BP1	170 25122	4260033151810
31	NH-9V200BP1	170 20122	4260033151728
<b>LITHIUM-ION RECHARGEABLE BATTERIES</b>			
31	ICR18650F-26bulk	17802600	4260216456831
31	ICR18650F-22bulk	17802200	4260216456824
<b>ULTRA FAST CHARGER</b>			
33	BC-0907	200 00907	4260033157706
33	BC-0907-UK Plug	200 01907	4260216456640
<b>SUPER FAST CHARGER</b>			
34	BC-0905A with UK Plug	200 01905	4260033157812
<b>FAST CHARGER</b>			
35	BC-1010B	20101010	4260216456473
36	BC-1002F	201 01002	4260216457340
37	BC-1012	201 01012	4260216453199
<b>OVERNIGHT CHARGER</b>			
38	BC-1001A	200 01001	4260033158260
38	BC-1001A with UK Plug	201 01001	4260216456480
39	BC-1009-2H23	201 01009	4260033155917
40	BC-0901	20000901	4260033157867
41	BC-0904S	20000904	4260033157850
<b>UNIVERSAL CHARGER</b>			
42	CM-9398	200 09398	4260030259403
43	CM-3298	200 03298	4260030255900
44	CM-9388	200 09388	4260033158512
45	LBC-313-1	20003131	4260216456756
46	LBC-321	20000321	4260216457135
<b>LITHIUM-ION CHARGER</b>			
47	LBC-305	20000305	4260216456763
<b>POWERBANKS</b>			
51	PS675	20200675	4260216456282
51	PS679	20200679	4260216456817
<b>USB POWER ADAPTERS</b>			
52	AD568-DB	200 00568	4260216455476
52	AD569-DB	200 00569	4260216454769
<b>USB CAR CHARGE</b>			
53	DD802	202 00802	4260216450563
53	DD823	20200823	4260216456343
<b>USB CHARGER-SET</b>			
54	3 in 1 USB Charger Set	200 00123	4260216456411
<b>LED FLASHLIGHTS</b>			
57	S31-D12	30200056	4260216456534

PAGE	PRODUCT	Art.No.	EAN Barcode
58	FL1L2DR20P	302 00026	4260033155542
58	FL1L2DD12	302 00043	4260033155610
58	FL1L2CB2R14P	302 00045	4260216454677
58	FL1L2AA2R6P	302 00025	4260033155566
58	FL1L2AAD24	302 00044	4260033155603
60	FL-16LED	302 00033	4260033155504
60	FL-9LED	302 00034	4260033155481
60	S32 2in1 Spotlight	30200055	4260216456718
60	CM25L	30200054	4260216456770
62	SL3013 LED Key Chain	302 00047	4260216456084
62	SL3013 LED Key Chain in Fishbowl with 36x pieces	302 00046	4260216454059
64	HP7011-3R03PBP	302 00028	4260216450136
64	PT1L2D-2R6PBP	302 00053	4260216456381
64	PT1L2AA-2R6PBP	302 00052	4260216456374
66	DL2AAS Aluminium Doctor Penlight incl. 2x CAM. Super Heavy Duty AAA batteries BLUE / blister	300 00017	4260033154347
67	T11-3R03PD12	302 00051	4260216456244
<b>LED FLASHLIGHTS CT-SERIES</b>			
68	CT4004	302 00011	4260030255733
70	S58-3LR03DB	302 00024	4260216457142
70	CT4007	302 00023	4260030255764
<b>COB LED WORK LIGHTS</b>			
72	SL5240N-3R6PD12	302 00049	4260216456152
72	SL7280N-3R03PD12	302 00048	4260216456169
74	S20 10W COB LED Worklight	30200057	4260216456800
74	S21 10W COB LED Floodlight	30200058	4260216456787
74	S22 20W COB LED Floodlight	30200059	4260216456794
76	SL7018-3R6TB	302 00050	4260216456312
<b>LED REPLACEMENT TUBS</b>			
77	BL304WN		
77	BL406WN		
77	BL608WN		
<b>BATTERY STANDS (FLOOR DISPLAYS / WIRE COUNTER DISPLAYS / STRIP)</b>			
79	WCD-02 Wire Counter Displays 6-hooks	501 00006	-
79	WCD 03 Wire Counter Display 9 hooks	501 00007	-
79	WCD-05 Floor Display 20-hooks	-	-
79	WCD-06 Floor Display 20-hooks	501 00015	-
79	MFD-02 Wire Counter Displays 16-hooks	501 00003	-
79	MFD 03 Floor Display 36 hooks	501 00001	-
79	MFD-06 Floor Display 80 hooks	501 00021	-
79	DR-11 Battery-Aisle Display Box 28 hooks H x W = 160 x 65cm	501 00020	-
79	DR-12 Battery-Aisle Display Box 9 hooks H x W = 70 x 32cm	501 00025	-
80	DR-16 8+4 Free	501 00029	-
80	DR-16 24	501 00028	-
80	DR-16 40	501 00027	-
81	HW-01	501 00004	-
81	HW-03	501 00005	-
81	HW-04		-
81	HW-05		-
81	HW-06		-
81	HW-07		-
81	various Promotional Accessories	-	-

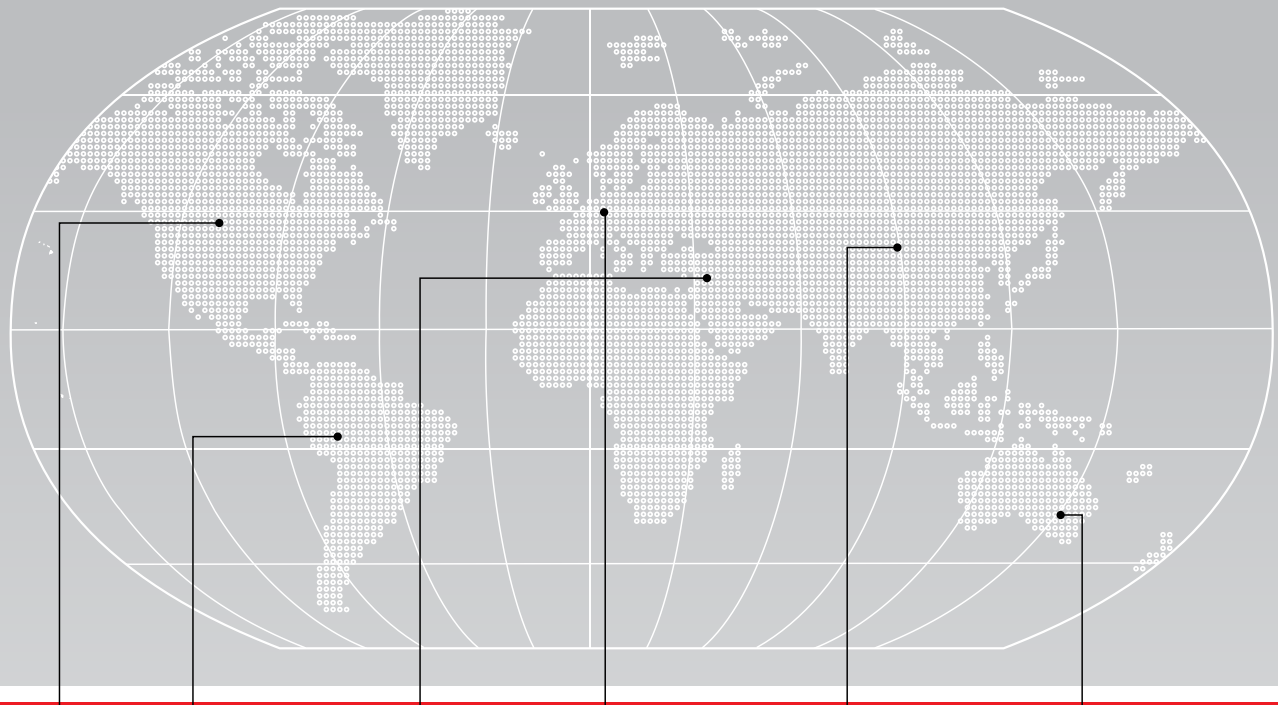

**North America**  
 • Canada  
 • U. S. A

**Caribbean/  
Latin America**  
 • Argentina  
 • Brazil  
 • Bolivia  
 • Chile  
 • Colombia  
 • Costa Rica  
 • Cuba  
 • Dominican  
 • Ecuador  
 • EL Salvador  
 • Guatemala  
 • Haiti  
 • Mexico  
 • Nicaragua  
 • Panama  
 • Paraguay  
 • Peru  
 • Puerto Rico  
 • Trinidad and Tobago  
 • Uruguay  
 • Venezuela

**Middle East  
/Africa**  
 • Algeria  
 • Benin  
 • Egypt  
 • Iran  
 • Israel  
 • Kuwait  
 • Lebanon  
 • Sierra Leone  
 • Saudi Arabia  
 • Syria  
 • S. Africa  
 • Tunisia  
 • U.A.E.  
 • Uganda

**Europe**  
 • Austria  
 • Albania  
 • Andorra  
 • Belarus  
 • Belgium  
 • Bosnia  
 • Bulgaria  
 • Czech Republic  
 • Croatia  
 • Cyprus  
 • Denmark  
 • Estonia  
 • Finland  
 • France  
 • Germany  
 • Georgia  
 • Greece  
 • Hungary  
 • Iceland  
 • Ireland  
 • Italy  
 • Montenegro  
 • Latvia  
 • Lithuania  
 • Luxembourg  
 • Macedonia  
 • Malta  
 • Netherland  
 • Norway  
 • Portugal  
 • Poland  
 • Romania  
 • Russia  
 • Serbia  
 • Slovakia  
 • Slovenia  
 • Spain  
 • Sweden  
 • Switzerland  
 • Turkey  
 • United Kingdom  
 • Ukraine

**Asia**  
 • Afghanistan  
 • Armenia  
 • Azerbaijan  
 • Bangladesh  
 • Cambodia  
 • China  
 • Hong Kong  
 • Indonesia  
 • India  
 • Iraq  
 • Japan  
 • Jordan  
 • Korea  
 • Kazakhstan  
 • Laos  
 • Malaysia  
 • Pakistan  
 • Philippines  
 • Singapore  
 • Sri Lanka  
 • Taiwan  
 • Thailand  
 • Turkmenistan  
 • Vietnam  
 • Yemen

**Oceania**  
 • Australia  
 • Fiji  
 • New Zealand

**EUROPE HEAD OFFICE / WAREHOUSE**

Camelion Batterien GmbH.  
 Bergiusstr. 53-59, D-12057 Berlin,  
 Germany



 Camelion Batterien GmbH



For more information visit [www.camelion.com](http://www.camelion.com)

Copyright ©2019 Batterien GmbH, All rights reserved